



 **Bioness Inc.**

25103 Rye Canyon Loop
Valencia, CA 91355 USA
Telephone: 800.211.9136 or 661.362.4850
Website: www.bioness.com



Bioness Europe B.V.

Stationsweg 41
3331 LR Zwijndrecht, The Netherlands
Telephone: +31.78.625.6088
Email: international@nl.bioness.com
Website: www.bioness.com

Rx Only



©2020 Bioness Inc.

StimRouter®, Bioness, the Bioness Logo® and LiveOn® are trademarks of Bioness Inc. in the United States or other countries. | www.bioness.com

612-00757-001 Rev. D
07/2020

StimRouter®

Neuromodulation System

Clinician's Guide



Copyright

©2020 by Bioness Inc. All Rights Reserved. No part of this publication may be reproduced, transmitted, transcribed, stored in a retrieval system or translated into any language or any computer language, in any form or by any third party, without the prior written permission of Bioness Inc.

Guarantees

Bioness Inc. reserves the right to modify, without prior notice, information relating to its products to improve their reliability or operating capacity.

Trademarks

StimRouter®, Bioness, the Bioness Logo® and LiveOn® are trademarks of Bioness Inc. in the United States or other countries. | www.bioness.com

Bioness Patents

This product is covered by one or more US and international patents. Additional patents pending. For more information on patents visit Bioness web site at: <http://www.bioness.com/Patents.php>

Disclaimer

Bioness Inc. shall not be liable for any injury or damage suffered by any person, either directly or indirectly, as a result of the unauthorized use or repair of Bioness Inc. products. Bioness does not accept any responsibility for any damage caused to its products, either directly or indirectly, as a result of use and/or repair by unauthorized personnel.

Environmental Policy



Service personnel are advised that when changing any part of the StimRouter system, care should be taken to dispose of those parts in the correct manner; where applicable, parts should be recycled. When the life cycle of a StimRouter component has been completed, the product should be discarded according to the laws and regulations of the local authority. For more information regarding these recommended procedures, please contact Bioness Inc. Bioness is committed to continuously seeking and implementing the best possible manufacturing procedures and servicing routines.



Bioness Inc.

25103 Rye Canyon Loop
Valencia, CA 91355 USA
Telephone: 800.211.9136 or 661.362.4850
Website: www.bioness.com



Bioness Europe B.V.

Stationsweg 41
3331 LR Zwijndrecht, The Netherlands
Telephone: +31.78.625.6088
Email: international@nl.bioness.com
Website: www.bioness.com

Conformity Certification



ETL CLASSIFIED



Intertek
3106069

List of Symbols

























	Caution
	Warning
	Class II Equipment (Double Insulated)
	Type BF Applied Part(s)
	Non-Ionizing Radiation
	Date of Manufacture
	Manufacturer
	This Product Must Not Be Disposed of with Other Household Waste
	Not Reading Instructions Can Cause Hazard
	Consult Instructions for Use
	Re-Order Number
	Lot Number
	Serial Number
	Complies with United States and Canadian Product Safety Standards
	Single Patient Use
	Single Use
	Storage Temperature
	Complies with the European Union Medical Device Directive
	European Authorized Representative
	Humidity Limitation
	Atmospheric Pressure Limitation
IPX3	Protection Against Ingress of Water
	Keep Dry
	Use By
	Quantity
Rx Only	Prescription Only
	Medical Device

Table of Contents

Chapter 1: Introduction	1
Chapter 2: Warnings and Precautions	3
Indications	3
Device Use and Stability	3
Device Materials	4
Essential Performance	4
Contraindications	4
Implantation Setting	5
Patient Screening	5
Warnings	6
Magnetic Resonance Imaging (MRI) Warnings and Precautions	6
StimRouter External Component Restrictions	6
MRI Safety Information	6
MR Conditional	6
Using the Transmit Body RF Coil	8
Using the Transmit RF Body Coil and the Receive-Only RF Head Coil	9
Using the Transmit/Receive RF Head Coil	9
Using the Transmit/Receive RF Knee Coil	9
Using the Transmit/Receive RF Hand/Wrist Coil	9
Using the Transmit/Receive RF Foot/Ankle Coil	10
MRI-Related Heating of the StimRouter Lead: Supplemental Information ...	13
1.5 T/64 MHz	13
3 T/128 MHz	14
Image Artifacts	14
Induced Currents	14
Potential Adverse Events	15
Pregnancy	15
Long-Term Effectiveness of Neurostimulation	15
Programming	15
Device Components	15
Flammable Fuel, Chemicals or Environment	16
Driving and Operating Machinery	16
Electromagnetic Compatibility Warnings	16
Medical Devices/Therapies	16

Electrosurgery Devices	17
High-Frequency Surgical Equipment	17
Body-Worn Devices	17
Security Screening Devices	17
Cell Phones	18
Precautions	18
Physician Training	18
Post-Operative Care	18
Implant Location	18
For Single Patient Use Only	18
Postural Changes	18
Keep out of Reach of Children	18
Skin Abnormalities	19
Skin Irritation	19
Known or Suspected Heart Problems	19
StimRouter Electrode Placement and Stimulation	19
Expiration Date	20
Implant Failure	20
Storage and Handling	20
Adverse Effects	20
Risks Related to the Implant Procedure	20
Risks Related to Stimulation	20
Additional Risks Related to the StimRouter System	21
Chapter 3: Clinical Experience	23
Safety	23
Effectiveness	23
Chapter 4: Environmental Conditions that Affect Use	25
Storage and Handling	25
Radio Communication Information	25
Conformity Certification	26
End-Of-Life Waste Management	26
Chapter 5: Patient Components	27
StimRouter Lead	27
StimRouter External Plus Transmitter (EPT)	27
Charging Socket and Charging Light	28
StimRouter Electrode	28

Patient Programmer	29
Operating Modes	30
<i>Standby Mode</i>	30
<i>Program Mode</i>	31
<i>Stimulation Mode</i>	31
Charging Socket and Connection Port	31
Chapter 6: StimRouter Clinician Kit	33
Chapter 7: Device Description	35
Programmer Connector Cable	35
Clinician's Programmer	35
Operating Buttons	36
Micro SD Slot	36
Touchscreen Display	36
Connector Port	36
Clinician's Programmer Micro SD Card	36
Clinician's Programmer Charger	36
Tester	37
StimRouter Software	37
Operating Modes	37
<i>Online</i>	37
<i>Offline</i>	37
Information Icon	38
Print Icon	39
Save Icon	39
Drop-Down Lists	39
Menu Bars and Menus	40
<i>Exit</i>	40
<i>Patients</i>	40
<i>Programs</i>	40
<i>History</i>	40
<i>Tools</i>	40
Tabs	40
Navigation Buttons	42
Intensity Level Bar	43
Program Bar	43
<i>Add Program Icon</i>	43

Delete Program Icon	43
Program Bar Arrows	43
Search Bars	43
Stimulation Parameters	44
Chapter 8: Clinician’s Programmer Set-Up	47
Connecting the Clinician’s Programmer and Programmer Connector Cable	47
Charging the Clinician’s Programmer	47
Connecting the Patient Programmer and Programmer Connector Cable	48
Logging into the StimRouter Software	48
Chapter 9: Software Records and History	51
Patient Records	51
Adding a New Patient	51
Copying a Record for an Existing Patient to an Unassigned System	52
Adding a Patient with an Assigned System	53
Opening a Patient Record	53
Modifying a Patient Record	54
Removing a Patient Record	54
Searching for a Patient Record	55
Usage History	55
Viewing a Usage History	56
Printing/Saving a Usage History	56
Session History	57
Viewing a Session History	57
Printing/Saving a Session History	58
Printing/Saving Multiple Sessions	58
Chapter 10: Patient Set-Up and Programming Instructions	59
Preparing the Patient’s Skin	59
Connecting the StimRouter Electrode and EPT	59
Adhering the StimRouter Electrode to the Skin	60
Confirming Set-Up	62
Removing the StimRouter Electrode	62
Programming Instructions	63
Programming Stimulation Settings	63
Programming Time Settings	65
Programs	66
Adding a Program	66

Saving a Program	66
Deleting a Program	67
Printing a Program	67
Chapter 11: Software Tools	69
Resetting the Patient Programmer and EPT	69
User Administration	70
Adding a User/Administrator	70
Removing a User/Administrator	71
Changing a User Password	71
Clinician's Programmer Database Backup and Restore	71
Enabling Automatic Database Backup	72
Manually Backing Up the Database	72
Restoring the Database	72
Chapter 12: Maintenance and Cleaning	75
Replacing StimRouter Electrode	75
Replacing the Patient Programmer Battery	75
Cleaning	76
Disinfecting	77
Electronic Components	77
Chapter 13: Troubleshooting	79
Patient Forgets Patient Programmer	79
Using a Clinic Patient Programmer	79
Registering the Patient Programmer/EPT	80
Patient Forgets EPT	82
Patient Loses EPT	82
Patient Brings New EPT and New Patient Programmer	82
Copying Patient Data to New Components	82
Testing the EPT	83
Troubleshooting Tables	84
Incident Reporting.....	38
Chapter 14: Technical Specifications	89
Wireless (RF) Communications Specifications	89
Troubleshooting Wireless Technology	90
Privacy of StimRouter Wireless Communication	90
Chapter 15: Appendix - EMI Tables	91
Electromagnetic Emissions	91

Guidance and Manufacturer’s Declaration Electromagnetic Emissions 91
Guidance and Manufacturer’s Declaration Electromagnetic Immunity 93
Recommended Separation Distances for Device 96

Introduction

The Bioness StimRouter Neuromodulation System is intended to help relieve chronic pain of peripheral origin. The Bioness StimRouter Neuromodulation System is made up of implanted components from the StimRouter Implantable Lead and Lead Introducer Kit (ST2-1000) and external components from the StimRouter User Kit (ST2-5015) and the StimRouter Clinician Kit (ST2-4000). The StimRouter system consists of the following:

- An implantable multi-electrode lead with integrated receiver in loader.
- Surgical tools for implantation of the StimRouter Lead.
- A clinician programming system with a Clinician's Programmer and charger, a Programmer Connector Cable, a Tester and accessories.
- A patient-operated system with a rechargeable External Pulse Transmitter (EPT), an external Patient Programmer, a system charger and accessories.
- Disposable StimRouter Electrodes.

This guide describes the clinician programming system components of the StimRouter Neuromodulation System, which are provided in the StimRouter Clinician Kit. The clinician programming components are used to program the patient's External Pulse Transmitter (EPT) and Patient Programmer.

Refer to the StimRouter Procedure Manual for a description of the StimRouter Implantable Lead and Lead Introducer Kit, package contents, device specifications and the StimRouter implant procedure.

Refer to the StimRouter User's Guide for a full description of the StimRouter User Kit, StimRouter Electrode, External Pulse Transmitter (EPT), Patient Programmer, external accessories, package contents, device specifications and instructions for use.

Warnings and Precautions

Physicians and patients should know the limitations, warnings, and precautions associated with the Bioness StimRouter Neuromodulation System. Physicians should review the warnings and precautions and the instructions for use with the patient. If at any time the physician or patient is concerned about the safety or effectiveness of the StimRouter System, they should call Bioness at 800.211.9136 or their local distributor.

The StimRouter Clinician Programmer and the patient-operated system consisting of the StimRouter Patient Programmer, StimRouter External Pulse Transmitter (EPT), and the StimRouter Electrode, should only be used under proper medical guidance and as described in the StimRouter Clinician's Guide and in the StimRouter User's Guide.

Indications

The StimRouter Neuromodulation System is indicated for pain management in adults who have severe, intractable chronic pain of peripheral nerve origin and as an adjunct to other modes of therapy (e.g., medications). The StimRouter is not intended to treat pain of craniofacial nerve origin.

Device Use and Suitability

The StimRouter System is designed to reduce pain in patients with chronic pain of peripheral nerve origin. Components of the Implantable Lead and Lead Introducer Kit and Clinician Kit are for use by trained clinicians, and components of the User Kit are for use by individual patients. Additional information, including clinical safety and performance, can be found at www.StimRouter.com.

The StimRouter system may not be suitable for treatment of acute pain, for pain that is not of peripheral nerve origin, or for patients whose required stimulation parameters cannot be met the StimRouter System. The StimRouter System implant procedure may be performed in any sterile surgical setting.

Device Materials

No Materials in the StimRouter Clinician Kit will directly contact the patient during device use. Materials in the StimRouter User Kit that may contact the patient during the device use include:

- Hydrogel
- Plastic

Both materials have been tested to verify biocompatibility.

Essential Performance

The StimRouter System does not have Essential Performance as there is no performance necessary (as defined by IEC 60601) to avoid unacceptable risks, in that all sources of identified risk have been mitigated (through application of appropriate risk control measures) to the greatest extent possible and to an acceptable degree. There are no sources of residual risk which outweigh the benefits accrued from the use of the device and which would thus be deemed unacceptable.

Contraindications

The Bioness StimRouter Neuromodulation System is contraindicated for:

- Patients who have any active implanted devices such as an implanted demand cardiac pacemaker, implantable cardioverter defibrillator (ICD), other implanted, active devices, or any metallic implant in the immediate area intended for implant.

Note: Maintain a minimum safe separation distance of 15 cm (6 in.) between the StimRouter Electrode with External Pulse Transmitter (EPT) and all other active implanted devices and metallic implants.

A risk/benefit determination should be performed before using the StimRouter system for:

- Patients exposed to diathermy. Shortwave, microwave, and/or therapeutic ultrasound diathermy should not be used on patients who have a StimRouter Neuromodulation System. The energy generated by diathermy can be transferred through the StimRouter system components, causing tissue damage at the lead site and potentially resulting in severe injury. Diathermy may also damage the StimRouter system components, resulting in loss of therapy. Injury or damage can occur during diathermy treatment whether neurostimulation is turned on or off. All patients are advised to inform their health-care professionals that they should not be exposed to diathermy.

- Patients exposed to therapeutic ultrasound.
- Patients who are unable to operate the StimRouter Neuromodulation System.
- Patients who are high surgical risks or who are poor surgical candidates in general.
- Patients who have a cancerous lesion near the target stimulation point or near where the StimRouter Electrode will adhere.
- Patients with bleeding disorders or active anticoagulation that cannot be stopped for a few days prior to the time of the surgical procedure.
- Do not use the transmit/receive RF head coil if the StimRouter Lead is implanted above the shoulder.

Implantation Setting

The StimRouter Lead should be implanted in an appropriately outfitted physician's office, outpatient surgical center, or hospital surgical center. Fluoroscopy and/or ultrasound should be available if deemed necessary and be used at the implanting physician's discretion.

Patient Screening

Candidates for the StimRouter Neuromodulation System should be appropriately screened for selection and fully informed about the therapy risks and benefits, the surgical procedure, system operation, and self-treatment responsibilities.

Select patients carefully to ensure that:

- Their symptoms are of an anatomical and/or physiological origin.
- They are appropriate candidates for surgery.
- They can properly operate the StimRouter system.

Bioness recommends the following optional screening procedure prior to StimRouter Lead implantation:

- Transcutaneous electrical nerve stimulation (TENS) to determine the patient's tolerance of stimulation near the anticipated site for the StimRouter Electrode. Please note that some individuals are very sensitive to the sensation of electrical stimulation applied to the skin.

Warnings

Magnetic Resonance Imaging (MRI) Warnings and Precautions

- An MRI examination performed on a patient with an implanted StimRouter Neuromodulation System Lead (i.e., StimRouter Lead) should only be done if there is a valid indication as determined by the supervising physician, and then only if all guidelines are carefully followed.
- All external components of the StimRouter system are contraindicated for the MR system room. Therefore, the StimRouter Electrode, External Pulse Transmitter, and Patient Programmer must be removed **before** the patient is allowed into the MR system room.
- Do not conduct an MRI examination on a patient with an implanted StimRouter Neuromodulation System Lead (i.e., StimRouter Lead) until you read and fully understand the information in the Clinician's Guide. Failure to follow all warnings and guidelines related to MRI can result in **SERIOUS INJURY** to the patient.
- The implanted StimRouter Lead should not be within transmit RF body coil unless the specific restrictions are followed for reduced radiofrequency (RF) power deposition (i.e., WBA SAR or B_{1+RMS} values) as presented in the Tables 2-1 and 2-2.
- Do not scan patients using a whole-body-averaged, specific absorption rate (SAR) level that exceeds 2 W/kg (i.e., with the MR system operating in the Normal Operating Mode). An MRI examination performed using a whole-body-averaged SAR above 2 W/kg may increase the risk of MRI-related heating, resulting in injury to the patient.

StimRouter External Component Restrictions

All external components of the StimRouter system are contraindicated for the MR system room. Therefore, the StimRouter Electrode, External Pulse Transmitter, and Patient Programmer must be removed before the patient is allowed into the MR system room.

MRI Safety Information



MR Conditional

Non-clinical testing demonstrated that the StimRouter Lead is **MR Conditional**. A patient with an implanted StimRouter Lead can be scanned safely, immediately

after implantation, under the following conditions:

- Static magnetic field of 1.5 T or 3 T, only
- Maximum spatial field gradient magnetic field of 2,500 gauss/cm (25 T/m)
- Specific conditions (see below) must be followed to ensure patient safety relative to the prevention of excessive heating of the StimRouter Lead
- If the entire StimRouter Lead is at least 50 cm away from the center of the bore of the MR system and the center of the transmit RF body coil, the reported, whole-body-averaged SAR must not exceed 2 W/kg at 1.5 T/64 MHz or a whole-body-averaged SAR of 2 W/kg at 3 T/128 MHz in the Normal Operating Mode of operation for the MR system
- Limit B1 and or SAR to values in Table 2.1 if the entire StimRouter is not at least 50 cm from the center of the MRI bore. (This is the Reduced RF Zone.)
- The patient must be conscious. Maintain communication with the patient so that the MRI examination can be terminated in the event of painful nerve stimulation or other adverse or unusual event
- Skin above StimRouter must not be in direct contact with the wall of the MRI bore. Use insulating padding of at least 1 cm thickness between the skin above StimRouter and the wall of the bore.
- Legs of patient do not touch each other.
- Arms of patient are not in contact with each other or the side of the body.
- MR system is in Normal Operating Mode for gradient magnetic fields.

Note: The precise anatomical position of the implanted StimRouter Lead is necessary to know prior to the MRI exam. Therefore, before initiating an MRI exam, the supervising clinician (e.g., the radiologist) should review the patient's Medical Device Identification Card, communicate directly with the implanting physician, and/or obtain an x-ray to determine the precise anatomic location of the implanted StimRouter Lead in the patient's body. Additionally, the patient must undergo a proper MRI screening procedure to determine the presence of a previously implanted (active or abandoned) medical device, including leads, lead extenders, lead adapters, and passive implants.

Position	WBA SAR 1.5 T	WB SAR 3 T	B1 +rms 1.5 T	B1 +rms 3 T
Upper Arm	0.4	0.6	1.2	0.7
Intercostal	0.4	0.6	1.2	0.7
Lower Leg	0.2	0.6	1.2	0.7
Upper Leg	0.4	0.6	1.2	0.7

Table 2.1. Whole body SAR and B1+rms limits for StimRouter inside the Reduced RF Zone, i.e. within 50 cm of center of the RF body coil. If B1+rms is not displayed on the MR system console, the whole body SAR limit is to be used.



WARNING: If the StimRouter Lead is at least 50 cm from the center of the bore of the MR system and the center of the transmit/receive RF body coil, DO NOT perform an MRI exam on the patient above a whole-body-averaged SAR of 2 W/kg in the Normal Operating Mode for a 1.5 T/64 MHz or a 3 T/128 MHz MR system. For a StimRouter Lead implant located inside the Reduced RF Zone (see Figures and Tables in this Guide) a reduced value of the whole-body-averaged SAR or, alternatively, the value of the B_{1+RMS} must be utilized in order to ensure acceptable tissue temperature increases based on the MRI conditions that are used for the MRI exam.

The “Reduced RF Zone” is defined as the anatomic area of the patient that will receive the RF power deposition during an MRI exam. When all or part of the StimRouter Lead is within a 50 cm distance from the center of the bore of the MR system and the center of the transmit RF body coil, this is referred to as the “Reduced RF Zone.” A reduced value of the whole-body-averaged SAR or, alternatively, the value of the B_{1+RMS} must be utilized in order to ensure acceptable tissue temperature increases based on the MRI conditions that are used for the MRI exam. See Tables 2-1 and 2-2 for the acceptable whole-body-averaged SAR and B_{1+RMS} values.

To ensure safety for a patient with an implanted StimRouter Lead, MRI healthcare professionals must adhere to the following conditions:

Using the Transmit Body RF Coil

When the entire StimRouter Lead is outside of the Reduced RF Zone and a receive-only RF coil is being used (note, any type of receive-only RF coil is permitted for use under these circumstances), the reported whole-body-averaged SAR must not exceed 2 W/kg at 1.5 T/64 MHz and 2 W/kg at 3 T/128 MHz (Figure 2-1). Do

not perform MRI in patients using a whole-body-averaged SAR level that exceeds 2 W/kg. An MRI exam scan performed using a whole-body-averaged SAR level above 2 W/kg may increase the risk of unacceptable MRI-related heating of the implanted StimRouter Lead.

When all or part of the StimRouter Lead is inside the Reduced RF Zone (Figure 2-1), reduced values of the whole-body-averaged (WBA) SAR or the B_{1+RMS} value must be used to result in acceptable tissue temperature increases. See Tables 2-1 and 2-2 for the WBA SAR or the B_{1+RMS} recommended for use when all or part of the StimRouter Lead is within the Reduced RF Zone during the MRI exam.

Using the Transmit RF Body Coil and the Receive-Only RF Head Coil

When all or part of the StimRouter Lead is inside of the Reduced RF Zone and a receive-only RF head coil is being used (Figure 2-2), reduced values of the whole-body-averaged (WBA) SAR or the B_{1+RMS} value must be used to result in acceptable tissue temperature increases. See Tables 2-1 and 2-2 for the WBA SAR or the B_{1+RMS} recommended for use when all or part of the StimRouter Lead is within the Reduced RF Zone during the MRI exam. Do not use the transmit RF Body Coil if the StimRouter Lead is implanted above the shoulder.

Using the Transmit/Receive RF Head Coil

Limit the head SAR to 3.2 W/kg using the Normal Operating Mode of operation for the MR system if the StimRouter Lead is located in the patient's shoulder or a lower anatomic position (Figure 2-3).

As previously mentioned in the contraindication section, do not use the transmit/receive RF head coil if the StimRouter Lead is implanted above the shoulder. Please refer to Chapter 2 for a complete list of contraindications.

Using the Transmit/Receive RF Knee Coil

MRI scans with the Transmit/Receive RF Knee Coil may be performed provided that StimRouter Lead is outside the coil and at least one coil radius away from the edge of the coil.

Do not scan if StimRouter is inside the coil or less than a coil radius away from the edge.

Using the Transmit/Receive RF Hand/Wrist Coil

MRI scans with the Transmit/Receive RF Knee Coil may be performed provided that StimRouter Lead is outside the coil and at least one coil radius away from the edge of the coil.

Do not scan if StimRouter is inside the coil or less than a coil radius away from the edge.

Using the Transmit/Receive RF Foot/Ankle Coil

MRI scans with the Transmit/Receive RF Knee Coil may be performed provided that StimRouter Lead is outside the coil and at least one coil radius away from the edge of the coil.

Do not scan if StimRouter is inside the coil or less than a coil radius away from the edge.

Note: The StimRouter Lead is considered to be outside of the “Reduced RF Zone” if the entire lead is located outside of the transmit RF body coil as shown in Figures 2-1 and 2-2, StimRouter Lead (A).

Note: The bore dimensions of clinical MR systems and associated transmit/receive RF coils will vary according to the type of MR system used on the patient with the StimRouter Lead.

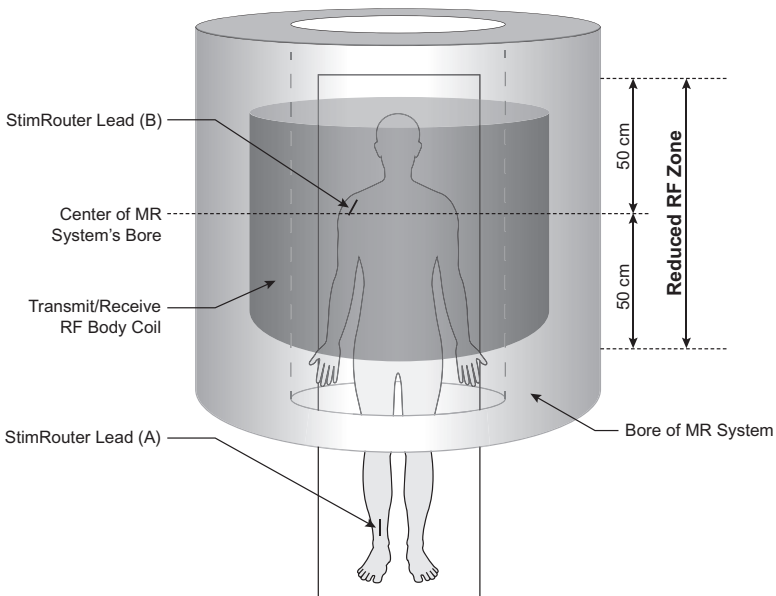

Figure 2-1: The StimRouter Lead (A) is located outside of the Reduced RF Zone and is more than 50 cm away from the center of the MR system's bore and the transmit/receive RF body coil. In this case, a whole-body-averaged SAR must not exceed 2 W/kg at 1.5 T/64 MHz or a whole-body-averaged SAR of 2 W/kg at 3 T/128 MHz in the Normal Operating Mode of operation for the MR system.

The StimRouter Lead (B) is located inside of the Reduced RF Zone.

The use of reduced WBA SAR or B_{1+RMS} values are required.

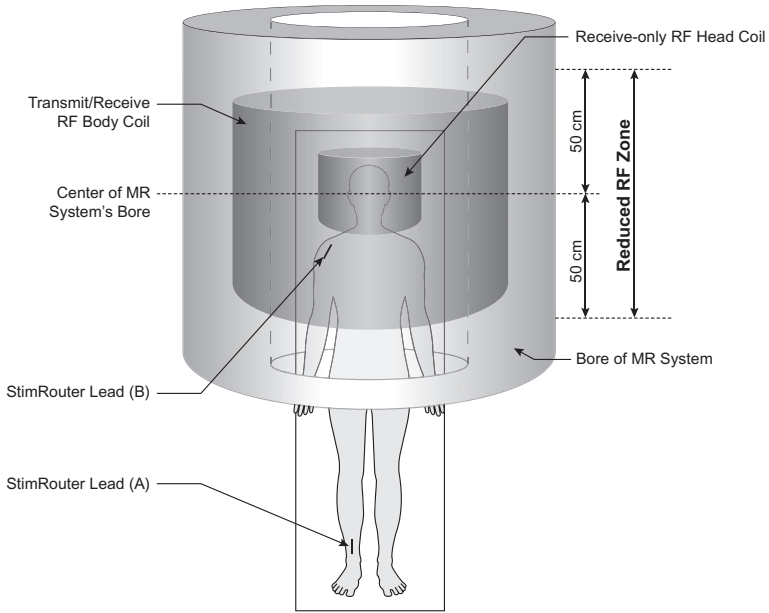

Figure 2-2: The transmit RF body coil and the receive-only RF head coil are being used with the StimRouter Lead (B) inside of the Reduced RF Zone. The use of reduced WBA SAR or B_{1+RMS} values are required.

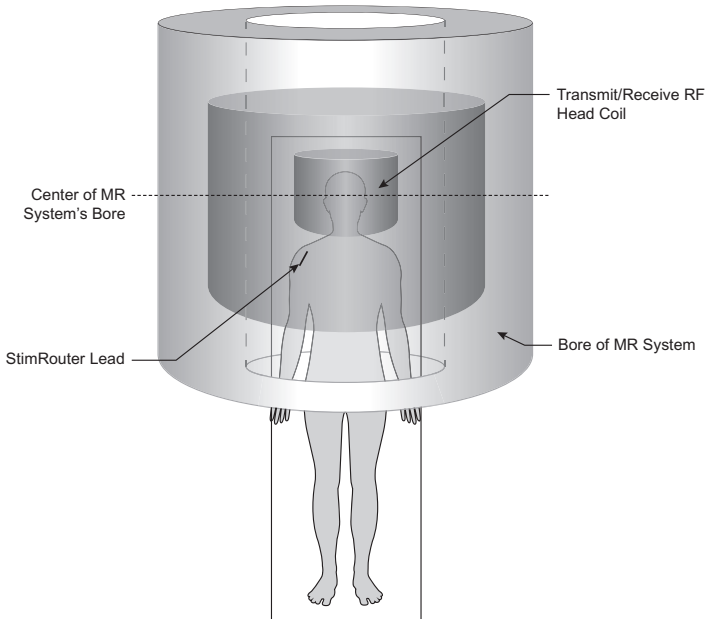

Figure 2-3: The transmit/receive RF head coil is being used.

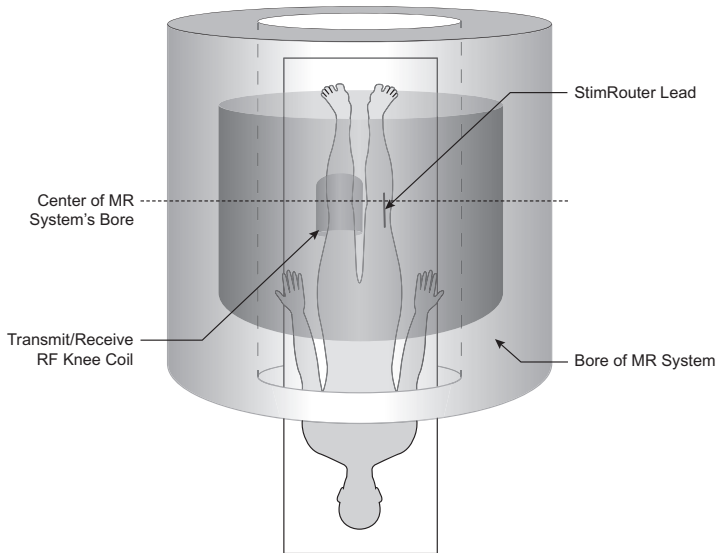

Figure 2-4: MRI scans with the Transmit/Receive RF Knee Coil may be performed provided that StimRouter Lead is outside the coil and at least one coil radius away from the edge of the coil.

Do not scan if StimRouter is inside the coil or less than a coil radius away from the edge.

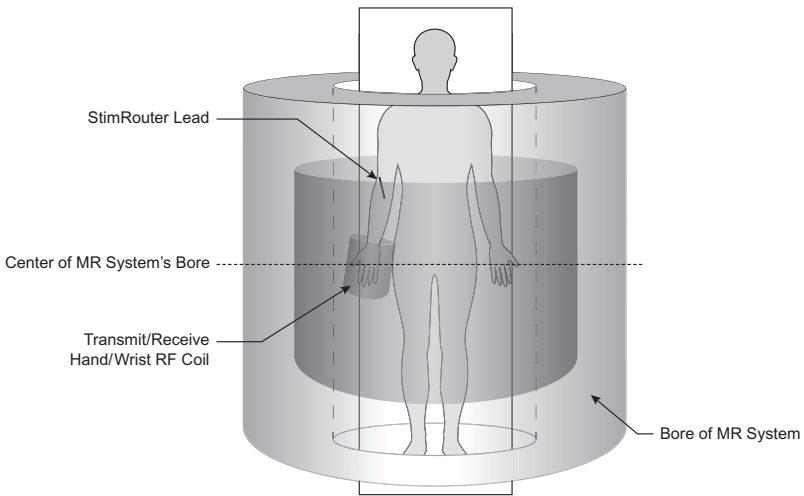

Figure 2-5: MRI scans with the Transmit/Receive RF hand/wrist Coil may be performed provided that StimRouter Lead is outside the coil and at least one coil radius away from the edge of the coil.

Do not scan if StimRouter is inside the coil or less than a coil radius away from the edge.

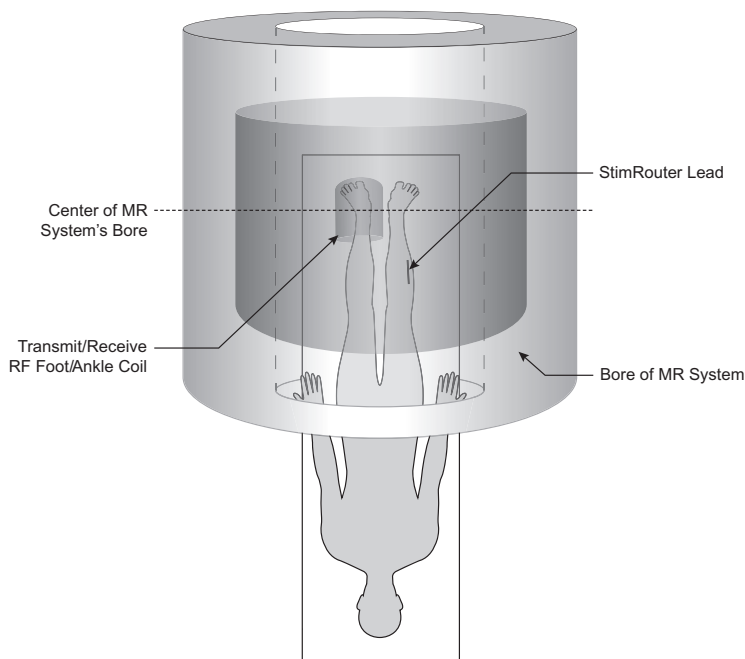

Figure 2-6: MRI scans with the Transmit/Receive RF foot/ankle Coil may be performed provided that StimRouter Lead is outside the coil and at least one coil radius away from the edge of the coil.

Do not scan if StimRouter is inside the coil or less than a coil radius away from the edge.

MRI-Related Heating of the StimRouter Lead: Supplemental Information

1.5 T/64 MHz

For situations where the entire StimRouter Lead is located **outside** of the Reduced RF Zone:

Temperature changes of the electrodes of the StimRouter Lead were measured at 1.5 T/64 MHz according to American Society for Testing and Materials (ASTM) International F2182 (i.e., using a 64-MHz transmit RF body coil). With the StimRouter Lead in an orientation and a position in the phantom¹ to produce worst-case heating, the greatest measured temperature rise scaled to a background local SAR of 1 W/kg was 3.9°C after six minutes of the application of RF power. This temperature change was with the StimRouter Lead in an elongated, “straight” configuration (i.e., no curves), which produced the highest temperature rise. With the StimRouter Lead in curved or looped configurations, temperature rises were less.

A computer simulation that incorporated the worst-case measured temperature

¹A “phantom” is a container filled with gelled saline that allows for the testing of MRI-related heating for implants.

rise at several anatomic locations and at a whole-body averaged SAR of 2 W/kg predicts a worst-case heating of an implanted StimRouter Lead in the patient during an MRI exam of less than 2°C after 15 minutes of continuous scanning (i.e., per pulse sequence) provided that the entire StimRouter Lead implant is outside of the Reduced RF Zone (see Figures 2-1 to 2-6).

For a StimRouter Lead implant located inside of the Reduced RF Zone, the worst-case heating was calculated to be less than 6°C for the values of whole-body-averaged (WBA) SAR and B1+RMS in Table 2.1.

3 T/128 MHz

For situations where the entire StimRouter Lead is located **outside** of the Reduced RF Zone:

Temperature changes of the StimRouter Lead electrodes were measured at 3 T/128 MHz according to ASTM International F2182 (i.e., using a 128-MHz transmit RF body coil). With the StimRouter Lead in an orientation and a position in the phantom¹ to produce worst-case heating, the greatest measured temperature rise scaled to a local background SAR of 2 W/kg was 2.9°C after six minutes of application of RF power. The highest temperature rise occurred with the StimRouter Lead in an elongated, “straight” configuration (i.e., no curves). Temperature rises were less when the StimRouter Lead was in curved or looped configurations.

A computer simulation showed that there would be less than a 1°C heating of an implanted StimRouter Lead in the patient during an MRI exam, provided the entire StimRouter Lead implant was outside of the Reduced RF Zone (see Figures). The computer simulation incorporated the worst-case measured temperature rise at several anatomic locations and a whole-body-averaged (WAR) SAR of 2 W/kg.

For a StimRouter Lead implant located inside of the Reduced RF Zone, the worst-case heating was calculated to be less than 6°C for the values of whole-body-averaged (WBA) SAR and B1+RMS in Table 2.1.

Image Artifacts

MR imaging quality may be compromised if the area of interest is in the same area or relatively close to the position of the StimRouter Lead. Therefore, optimization of MRI parameters to compensate for the presence of the StimRouter Lead may be necessary.

Induced Currents

The electric fields induced in a patient with the StimRouter Lead by the time-varying, gradient magnetic fields used during MRI were calculated.

If the StimRouter Lead is at least 50 cm from the center of the bore of the MR system and outside the gradient coils of the MR system, the induced current will

be less than the stimulation threshold. However, the induced current may reach the stimulation threshold if the StimRouter Lead is located less than 50 cm from the center of the bore of the MR system and the center of the transmit RF body coil (i.e., the approximate area inside the “Reduced RF Zone”).

 **CAUTION:** Electrical current induced in the StimRouter Lead during MR procedure may cause stimulation of the nerves proximal to the lead causing sensation, motor response, or nerve blocking.

Potential Adverse Events

The utilization of MRI could result in excessive heating of the StimRouter Lead if all MRI parameters and conditions of use are not carefully followed.

Induced voltages in the StimRouter Lead may occur due to the time-varying, gradient magnetic fields of the MR system, possibly causing uncomfortable levels of neurostimulation.

Note: Since the StimRouter Lead is not a life-sustaining device, it could be explanted from the patient prior to an MRI exam and re-implanted after the MRI exam.

Pregnancy

The effects of electrical stimulation on pregnancy are unknown. Do not use electrical stimulation on a pregnant patient.

Long-Term Effectiveness of Neurostimulation

The long-term effectiveness of neurostimulation is not known.

Programming

The StimRouter components should only be programmed by the treating physician and/or under proper medical guidance.

Device Components

The use of non-Bioness components with the StimRouter system may result in damage to the system and increased risk to the patient.

No modification of this equipment is allowed.

The Patient Programmer and External Pulse Transmitter (EPT) can heat up to 43°C during operation in extremely hot areas/rooms. If this occurs turn off stimulation, remove EPT and Patient Programmer, and set aside until temperature is within operational conditions.

Flammable Fuel, Chemicals or Environment

The StimRouter is not intended to be used in oxygen-rich environments.

Advise patients to turn off the StimRouter system (Patient Programmer and stimulation) when near a refueling station, flammable fuel, fumes, or chemicals. The operation of the StimRouter could cause the chemicals or fumes to ignite, causing severe burns, injury, or death.

Driving and Operating Machinery

StimRouter stimulation should be off while driving or operating machinery.

Electromagnetic Compatibility Warnings

Medical Devices/Therapies

Operation of the StimRouter Neuromodulation System in close proximity (e.g., 1 meter) to shortwave or microwave therapy equipment may produce instability in the EPT output.

The following medical therapies or procedures may turn stimulation off, may cause permanent damage to the external components, and may injure the patient, particularly if used in close proximity to the system components:

- Lithotripsy
- Electrocautery
- External defibrillation
- Ultrasonic scanning
- High-output ultrasound

Electromagnetic interference (EMI) from the following medical procedures is unlikely to affect the StimRouter system:

- Computerized Axial Tomography (CT or CAT) scans
- Diagnostic ultrasound (e.g., carotid scan, Doppler studies)
- Diagnostic x-rays or fluoroscopy

Note: Advise patients to remove the StimRouter Electrode before undergoing medical therapies or procedures.

Electrosurgery Devices

Electrosurgery devices should not be used near an implanted StimRouter Lead. Contact between an active electrode of the electrosurgery device and the implanted lead can stimulate the lead and cause severe injury.

High-Frequency Surgical Equipment

Simultaneous connection of a patient to the StimRouter components and high-frequency surgical equipment may result in skin burns where the gel electrodes adhere to the skin and may damage the StimRouter EPT. Advise patients to remove the StimRouter electrode before medical treatment.

Body-Worn Devices

Although unlikely, body-worn medical devices may interfere with the RF communication used in the StimRouter System. Stimulation control may be delayed. Examples of a body-worn device are a pain pump or an insulin pump and a monitoring device. The Patient Programmer will emit visual alerts if interference occurs. To minimize interference, maintain a minimum safe separation distance of 15 cm (6 in.) between the StimRouter system and all other electronic devices. Refer to the Troubleshooting section for help and the Appendix for more information.

The StimRouter System wireless technology may cause EMI to other body-worn medical devices. Refer to the instructions for use for those devices for information on recommended minimum separation distances.

Security Screening Devices

Certain types of security devices may affect stimulation. Examples include those used at the entrances and exits of public buildings such as libraries, airports, and retail stores. Have patients ask for help to bypass the screening device and show their Medical Device Identification Card. If they must pass through the device, they should:

- Turn off the StimRouter system.
- Pass through the security-screening device quickly.
- Stay as far from the emitter as possible (e.g., walk in the center of a pass-through security gate).

Cell Phones

There is potential for interference between electronic devices, including cell phones. Stimulation control may be delayed. If interference is suspected or anticipated, maintain a distance from the source of interference. To minimize interference, a minimum safe separation distance of 15 cm (6 in.) should be maintained between the StimRouter system and all other electronic devices.

Precautions

Physician Training

Bioness requires that its personnel formally train physicians using the StimRouter Neuromodulation System in the system's operation and use.

Post-Operative Care

Physicians should adequately observe the incision site and monitor for infection, possible device rejection, or other possible adverse effects. If the patient notices excessive redness or discharge around the incision site, then the implant physician should be contacted immediately to check for infection and administer proper treatment following standard medical procedures.

Implant Location

Advise patients to never manipulate the StimRouter Lead. If the lead is moved from the target stimulation point, then it may not function correctly or effectively. In some instances a lead can move from its original location, thus causing a loss of stimulation at the target stimulation point. If the lead moves, then it may need to be replaced.

For Single Patient Use Only

The StimRouter Electrode should be worn only by the patient for whom it is prescribed and in the location for which it is prescribed. The StimRouter Electrode should not be adhered to any other person or any other place on the patient's body.

Postural Changes

Changes in posture or abrupt movements may decrease or increase the perceived level of stimulation. Advise patients to turn off stimulation before making extreme posture changes or abrupt movements such as stretching or exercising.

Keep out of Reach of Children

The StimRouter components should be kept out of the reach of children.

Skin Abnormalities

Do not adhere the StimRouter Electrode to sites that are swollen, infected or inflamed, or that have skin eruptions such as phlebitis, thrombophlebitis, and/or varicose veins. Do not adhere the StimRouter Electrode to skin that is breached.

Skin Irritation

It is normal for the skin under the StimRouter Electrode to become red. The redness should disappear in approximately one hour once the electrode is removed. However, some patients may experience skin irritation, an allergic reaction, or hypersensitivity to the electrical stimulation or the gel pads on the back of the StimRouter Electrode. Persistent redness, lesions or blisters are signs of irritation. Use of the StimRouter components should be temporarily halted until the irritation is resolved. In some cases, removing the StimRouter Electrode periodically to allow the skin to breathe and changing the stimulation parameters can avoid irritation. Patients should consult their physician if irritation persists.

Known or Suspected Heart Problems

Use caution when treating patients with suspected or diagnosed heart problems.

StimRouter Electrode Placement and Stimulation

- Electrical stimulation should not be applied trans-thoracically or at the heart, as the current may travel into or through the cardiac tissue. Such an introduction of electrical current may cause heart rhythm disturbances.
- Avoid placing the StimRouter Electrode across or through the head, directly on the eyes, covering the mouth, or on the front of the neck, (especially the carotid sinus).
- Turn off stimulation before adhering, removing, or handling the StimRouter Electrode.
- The implanting physician should determine StimRouter Electrode placement and stimulation settings.
- Do not apply the StimRouter Electrode over any obstruction that would reduce the designated electrode surface area (e.g., an adhesive bandage). A smaller electrode surface area could result in serious injury to the patient. Do not apply the StimRouter Electrode over skin folds, scarred tissue, irritated skin, uneven skin surfaces, or broken skin.
- Always inspect the gel pads on the back of the StimRouter Electrode before use. Do not apply the StimRouter electrode if the gel pads appear dried out, worn, dirty, or irregular.
- Make sure the StimRouter Electrode liner is removed before adhering to the skin.

- Do not handle the StimRouter Electrode with both hands while stimulation is on, as serious injury can result from the current passing through the cardiac tissues.

Expiration Date

Do not use a StimRouter Electrode with an expired “Use by” date.

Implant Failure

Leads may fail at any time because of random component failure or lead breakage. If component failure or lead breakage occurs, then the lead may need to be removed or replaced. It is possible that there will be retained lead fragments during attempted explants, which will make certain procedures contraindicated indefinitely (e.g., diathermy, therapeutic ultrasound, or MRI in the affected area). Immediately contact your physician, if implant failure is suspected.

Storage and Handling

All StimRouter components and accessories should be handled with care. Components and accessories should not be dropped. Although reliability testing has been performed to ensure quality manufacturing and performance, dropping the components on hard surfaces, or other rough handling, can permanently damage the components.

Adverse Effects

In the unlikely event that any of the following occurs, patients should stop using their StimRouter System, remove the StimRouter Electrode, and immediately contact their physician.

Risks Related to the Implant Procedure

Suboptimal lead placement may necessitate therapeutic adjustment and/or lead explant. Nerve injury is possible, although unlikely. Possible surgical complications include infection, cellulitis, abscess, fever, sepsis, bleeding, and temporary pain at the implant site.

Risks Related to Stimulation

Operation of the StimRouter components may cause increased pain in an area other than the lead site. This pain may be caused by stimulation of the tissue surrounding the stimulation electrodes (e.g., skin, fascia, and muscle).

Patients may also experience an undesirable motor response during stimulation.

If patients experience any pain or discomfort during stimulation, or notice any skin abnormalities, they should stop stimulation immediately, remove the StimRouter Electrode, and contact their physician.

Additional Risks Related to the StimRouter System

- Migration of the lead may cause changes in stimulation effectiveness.
- A tissue reaction to any of the implanted materials may occur.
- External electromagnetic interference may cause the StimRouter components to malfunction and may affect stimulation.
- Patients may experience persistent pain at the implant site of the lead.
- Although rare, the skin overlying the lead may erode.
- Portable and mobile radio frequency communications equipment can affect medical electrical equipment.
- The StimRouter external components could overheat if the components fail, which could cause burning.
- If patients experience any pain or discomfort during stimulation, or notice any skin abnormalities, they should stop stimulation immediately, cease contact with the StimRouter components, and contact their physician.

Clinical Experience

A prospective, multi-center, randomized, double-blinded, partial crossover, three-stage group sequential trial was conducted to evaluate the safety and effectiveness of the StimRouter System for pain management in adults who have severe intractable chronic pain of peripheral nerve origin, as an adjunct to other modes of therapy. Ninety-four (94) subjects with intractable chronic pain were enrolled in the study, each of whom was implanted with a StimRouter Lead. Forty-five (45) subjects were randomized into the treatment (active stimulation) group, and 49 subjects were randomized into the control (non-stimulation) group. At 3 months post-randomization, control subjects crossed over to the treatment group. Subjects recorded and reported pain on a numeric rating scale prior to lead placement and after lead placement and randomization at follow-up evaluations. Adverse events were also reported at these follow-up evaluations, which were conducted approximately 1, 2, 3, 6, and 12 months after randomization.

Safety

The safety of the StimRouter System is based on all 94 patients implanted with a StimRouter Lead. Of the 94 subjects implanted with the StimRouter lead, none experienced unanticipated or serious adverse events related to the device or therapy. 51 adverse events in 27 subjects were considered to be related to the device or therapy. The adverse events included: pain, numbness, bruising, or muscle spasm related to patch/stimulation (n=19); localized skin reaction related to stimulation site (n=18); post-procedure pain/swelling/ pain at implant site (n=9); receiving end of lead exposed (n=2); lead broke during explant, leaving partial implant (n=1); infection at incision site post-implant (n=1); and nausea (n=1).

Effectiveness

The primary effectiveness endpoint required a statistically significant difference between the treatment and control groups in proportion of subjects achieving clinically important pain reduction at 3 months after randomization. Clinically important pain relief was defined as $\geq 30\%$ reduction from baseline in average pain as measured by the numeric rating scale. The primary effectiveness endpoint was achieved, with 17 (37.8%) of the 45 subjects in the treatment group achieving clinically important pain reduction, compared to 5 (10.2%) of 49 subjects in the control group. Because

effective blinding is difficult to achieve in nerve stimulation studies, there was risk of the placebo effect in this study, which could cause the study results to overstate the difference in benefit between the control and treatment groups.

Environmental Conditions that Affect Use

Storage and Handling

All StimRouter components should be kept dry and protected from extreme changes in temperature and humidity. Do not use or store components where they could come in contact with water, such as by sinks, bathtubs and shower stalls, or expose them to weather conditions such as rain or snow. Do not store StimRouter components in a car where they can be exposed to extreme hot or cold temperatures. Temperature extremes can damage the StimRouter components.

To avoid condensation when transporting StimRouter components from hot to cold temperatures, place the components in an air-tight plastic bag first. Let them adjust slowly (for at least two hours) to the change in temperature before use.

Radio Communication Information

Several components of the StimRouter system communicate via radio communication and have been tested and found to comply with the limits for a Class B digital device, pursuant to Part 15 (Radio Frequency Devices) of the FCC Rules. These limits are designed to provide reasonable protection against harmful interference in a residential environment. This equipment generates, uses and can radiate radio frequency energy and, if not operated and used in accordance with the instructions, may cause harmful interference to radio communications. However, there is no guarantee that interference will not occur in a particular environment. If this equipment does cause harmful interference to radio or television reception, which can be determined by turning the equipment off and on, then try to correct the interference by one or more of the following measures:

- Reorient or relocate the receiving antenna.
- Increase the separation between the equipment and receiver.
- Consult the dealer or an experienced radio/television technician for assistance.

The antenna for each transmitter must not be located near to or operating in conjunction with any other antenna or transmitter.

Changes or modifications to components not expressly approved by Bioness could void the user's authority to operate the equipment.

Conformity Certification

The StimRouter complies with Part 15 of the FCC Rules. Operation is subject to the following two conditions:

1. This device may not cause harmful interference
2. This device must accept any interference received, including interference that may cause undesired operation.

End-Of-Life Waste Management

WEEE Regulations place an obligation on distributors to offer consumers a take-back system where WEEE items can be disposed of free of charge. In our role as an exporter of electrical or electronic equipment to European countries, include EU members and the United Kingdom, Bioness Inc. currently requests patients using the Bioness StimRouter External Pulse Transmitter and/or the Bioness StimRouter Patient Programmer for their in-home medical treatments to contact Bioness Inc. Product Support for information on how to properly dispose of these electrical/electronic equipment. At this time, Bioness EU Product Support informs these householder patients to not dispose of these items with their household waste. Instead, householders are told to instead take these items to the nearest household waste recycling or civic amenity center.

Patient Components

StimRouter Lead

The StimRouter Lead is flexible and approximately 15 cm (6 in.) in length. The lead has a stimulation end and a receiver end. The stimulation end is implanted near or at the targeted peripheral nerve and the receiver end is implanted near the skin surface. The receiver end receives the stimulation signal from the EPT and then sends the signal through the lead to the stimulation end. See Figure 5-1.



Figure 5-1: The StimRouter Lead

StimRouter External Pulse Transmitter (EPT)

The StimRouter EPT generates the stimulation signal and transmits the signal through the StimRouter Electrode to the StimRouter Lead. The EPT snaps onto the StimRouter Electrode (See Figure 5-2) and responds to wireless commands from the Patient Programmer.

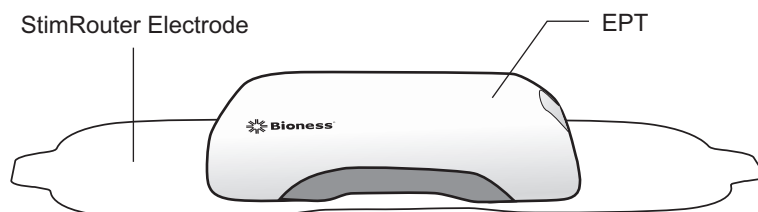

Figure 5-2: The EPT attached to the StimRouter Electrode

Charging Socket and Charging Light

The EPT charging socket is located on the front panel of the EPT under the flexible cover. When the EPT is charging a green charging light will appear on the side panel of the EPT. See Figure 5-3.



Figure 5-3: The EPT charging socket and charging light location

StimRouter Electrode

The StimRouter Electrode features: (See Figure 5-4)

- Two gel pads that adhere the StimRouter Electrode to the skin. The gel pads also transmit the stimulation signal from the EPT to the receiver end of the lead.
- Two snaps for EPT placement.
- Two tabs for removing the StimRouter Electrode from the skin.
- A liner to protect the gel pads on the back of the StimRouter Electrode.

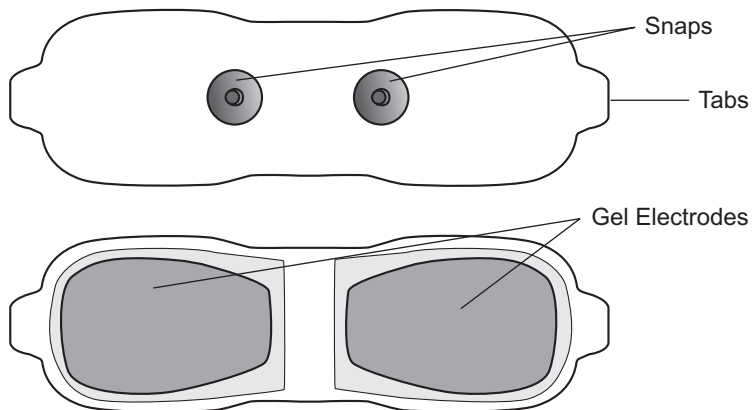

Figure 5-4: StimRouter Electrode (top and bottom views)

The StimRouter Electrode is disposable and can be reused by the same patient as long as the gel pads are intact and can fully adhere to the skin or for a maximum of four days of use.

The typical lifespan of the StimRouter Electrode is two to four days, depending on:

- The number of hours of use.
- The number of times the StimRouter Electrode is adhered and removed from the skin.
- Hygiene and skin care in the area of StimRouter Electrode placement.

Patient Programmer

The Patient Programmer communicates wirelessly with the EPT. The Patient Programmer is used to turn stimulation on and off, to adjust the stimulation intensity and to select a stimulation program.

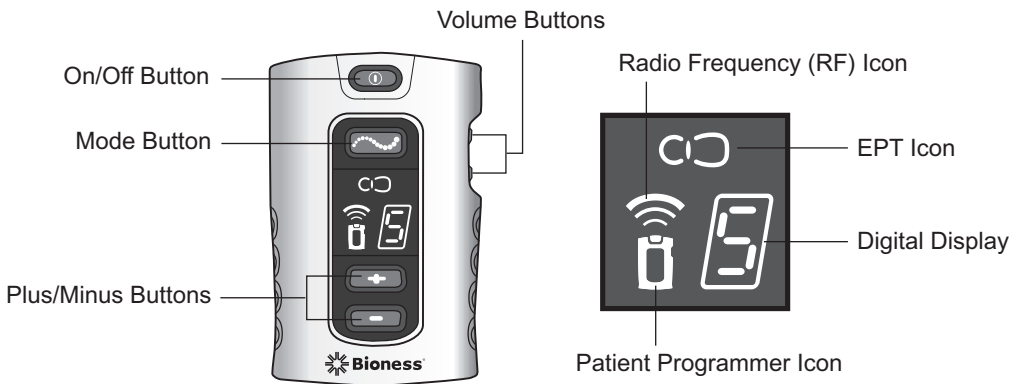

Figure 5-5: Patient Programmer operating buttons, information icons and digital display





Operating Buttons	Description	Function
	On/Off Button	Turns the system on and off.
	Mode Button	Selects standby, program and stimulation mode.
	Plus/Minus Buttons	Used to increase or decrease stimulation intensity and to select a stimulation program.
	Volume Buttons	Used to increase, decrease and mute the sound level of the audio alerts.

Table 5-1: Patient Programmer operating buttons and functions









Visual Displays	Description	Definition
	On/Off Button Flashes Green	Patient Programmer is on.
	Mode Button Flashes Yellow	Stimulation is on.
	Mode Button Glows Yellow	Patient Programmer is in program mode.
	Digital Displays 0-9	Stimulation intensity level.
	Digital Displays A-H	Stimulation programs.
	Rotating Green Loop	Charge level is low.
	Rotating Green Loop	Charge level is high.
	Horizontal Green Line	Battery is fully charged.

Table 5-2: Patient Programmer visual displays and definitions

Operating Modes

The Patient Programmer has three operating modes: standby, program and stimulation.

Standby Mode

In standby mode, the Patient Programmer is ON and ready for commands. The Patient Programmer turns on in standby mode and returns to standby mode when program mode and stimulation mode are exited.

Program Mode

In program mode, a patient may select between different stimulation programs.

Stimulation Mode

In stimulation mode, the StimRouter components are stimulating the target treatment area. A patient can adjust the intensity level of stimulation.

Charging Socket and Connection Port

The Patient Programmer charging socket and the connection port are located at the bottom of the Patient Programmer, under the flexible cover. See Figure 5-6. The connection port is used to connect the Patient Programmer to the Programmer Connector Cable and Clinician's Programmer during a programming session.

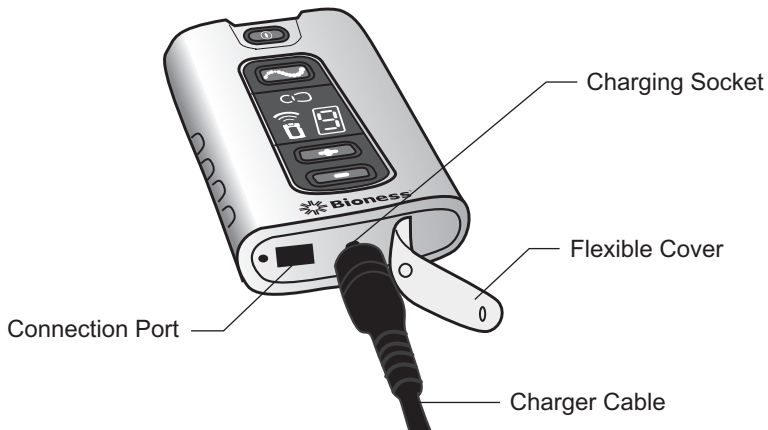
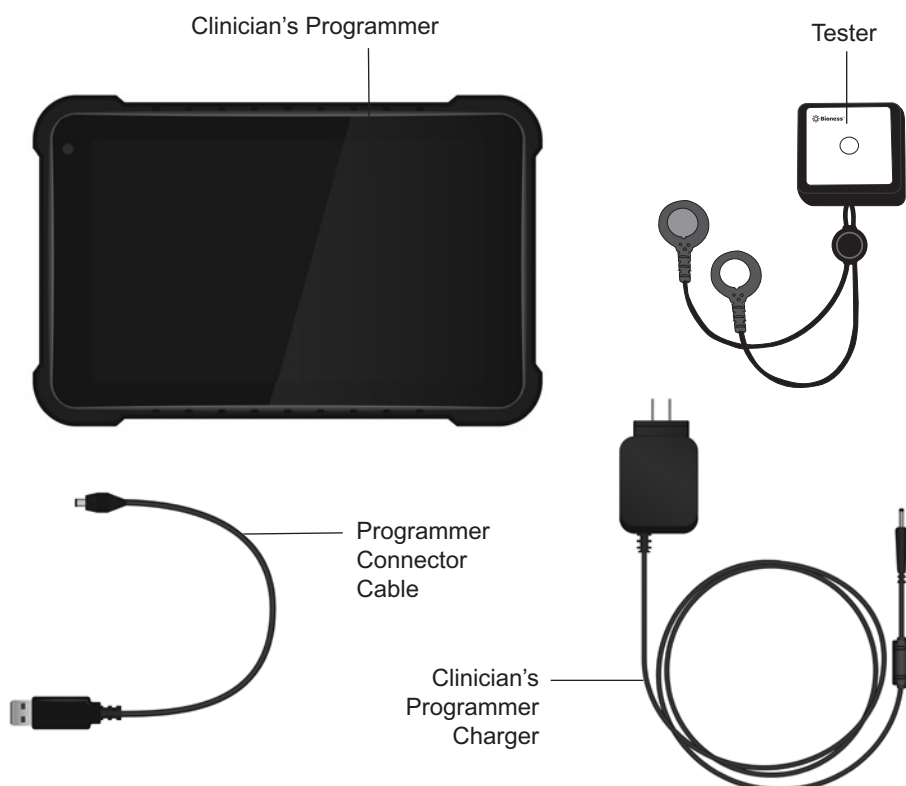

Figure 5-6: Patient Programmer charging socket and connection port

StimRouter Clinician Kit

The StimRouter Clinician Kit includes the following:

- Clinician's Programmer, Tablet with Software and Stylus
- Clinician's Programmer Micro SD Card
- Clinician's Programmer Charger
- Tester
- Clinician's Reference Card
- Clinician's Manual
- Programmer Connector Cable



Device Description

Programmer Connector Cable

The Programmer Connector Cable is used to connect the Clinician's Programmer to the Patient Programmer. See Figure 7-1.

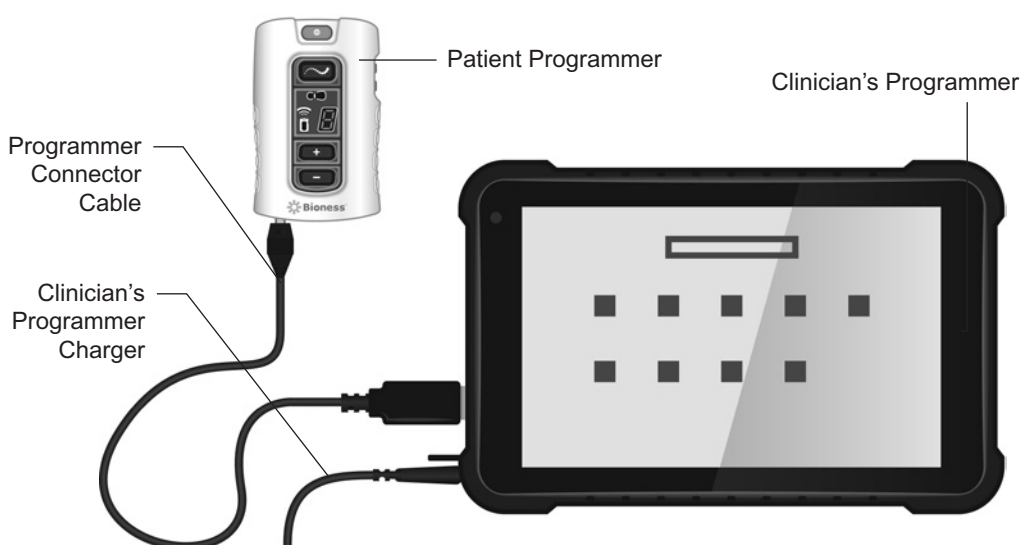





Figure 7-1: The Clinician's Programmer and Patient Programmer connected

Clinician's Programmer

The StimRouter Clinician's Programmer is used to program, test and save stimulation parameters and programs on the StimRouter EPT and Patient Programmer. The Clinician's Programmer is a Windows® Tablet PC that comes with the StimRouter software and a memory card installed. See Figure 7-1. The Clinician's Programmer can wirelessly communicate with the EPT, when connected to the Patient Programmer via the Programmer Connector Cable.

Operating Buttons

Buttons	Description	Function
	Scan Button	Used to scan bar codes
	Power Button	Used to turn the Clinician's Programmer on and off
	Volume Up Button	Used to turn the Clinician Programmer volume up
	Volume Down Button	Used to turn the Clinician Programmer volume down

Micro SD Slot

Contains the Clinician's Programmer micro SD card.

Touchscreen Display

Used to navigate the StimRouter software, read statuses and enter data. Use the pointed end of the stylus to make contact with the display screen.

Connector Port

For use with the Programmer Connector Cable.

Clinician's Programmer Micro SD Card

Used to back up and restore the Clinician's Programmer database. The micro SD card is supplied installed in the SD slot of the Clinician's Programmer.

 **WARNING:** The Clinician's Programmer should only contain the installed Windows® operating system and Bioness Inc. proprietary StimRouter software. Do not use the Clinician's Programmer for any purpose other than that described in this manual. Third-party software packages are not supported and may interfere with proper operation of the StimRouter components, thus voiding the warranty.

Clinician's Programmer Charger

Used to recharge the Clinician's Programmer.

 **WARNING:** Use only the clinician's Programmer Charger included in StimRouter Clinician Kit.

Tester

The tester is used to confirm the EPT is delivering stimulation when troubleshooting technical issues with the EPT. It provides audio feedback when connected and stimulation is applied. See Figure 7-2.

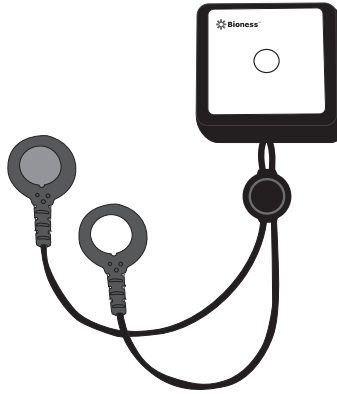

Figure 7-2: The tester

StimRouter Software

The StimRouter software is provided installed on the Clinician's Programmer.

Operating Modes

The StimRouter software has two operating modes: online and offline.

Online. The StimRouter Clinician's Programmer is online when connected to an operational StimRouter Patient Programmer and EPT. See Table 7-1.

Offline. The StimRouter Clinician's Programmer is offline when not connected to an operational StimRouter Patient Programmer and EPT. See Table 7-1.

Operating Mode	Function Descriptions
Online	<ul style="list-style-type: none"> • Add a new patient. • Modify a patient name. • Open a patient record. • View/print/save a patient's history. • Program stimulation settings. • Program time settings. • Add or remove a stimulation program. • View the system information. • Reset the EPT and Patient Programmer. • Back up the database. • Restore the Clinician's Programmer database. • Add a new user. • Remove a user. • Change a user password.
Offline	<ul style="list-style-type: none"> • Open any patient record. • Remove a patient record. • View/print/save a patient's history. • View a patient's programs. • Back up the Clinician's Programmer database. • Restore the Clinician's Programmer database. • Add a new user. • Remove a user. • Change a user password.

Table 7-1: StimRouter software operating modes and function descriptions

Information Icon

Used to communicate system status, error messages and troubleshooting solutions. When the icon is RED or YELLOW, press the icon for more information. See Figure 7-3.

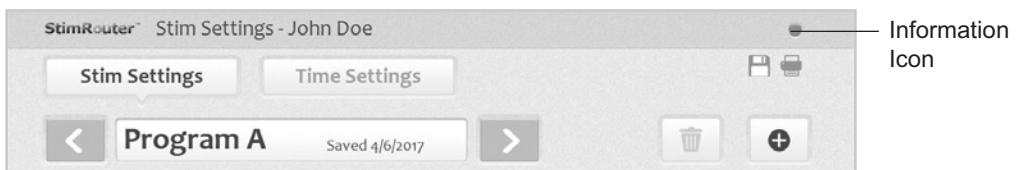

Figure 7-3: Location of the information icon



GREEN when the StimRouter is online; GRAY when no Patient Programmer is detected.



FLASHING RED when a Patient Programmer is connected and a correctable error has occurred (for example, RF communication failure).



CONSTANT RED when a Patient Programmer is connected and an error has occurred.



FLASHING YELLOW when the StimRouter Patient Programmer or EPT battery charge level is low.

Print Icon



Used to print patient reports.

Save Icon



Used to save patient reports.

Drop-Down Lists

Used to select a value. Press the down arrow to display the values. Select a value. See Figure 7-4.

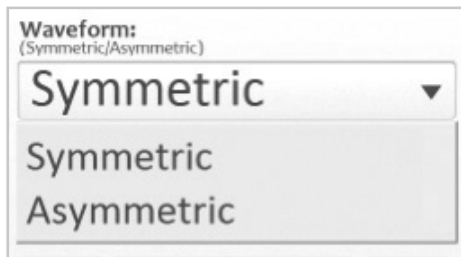

Figure 7-4: Illustrative drop-down lists for waveform

Menu Bar and Menus

The StimRouter software has five navigation menus, which appear on the menu bar. See Figure 7-5.

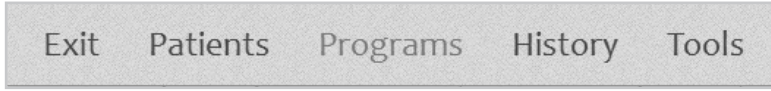

Figure 7-5: Menu bar

Exit. Used to exit or logoff the StimRouter software.

Patients. Used to open a patient record, add a new patient, modify a patient record or remove a patient record.

Programs. Used to program, test and save a set of stimulation and time settings. (Enabled when a patient record is open.)

History. Used to view, print or save a patient's usage log or session history. (Enabled when a patient record is open.)

Tools. Used to view system information and to reset the Patient Programmer and EPT. Users with administrator privileges can also add and remove users, change a user password, and back up and restore the Clinician's Programmer database.

Tabs

The StimRouter software has eight navigation tabs, or submenus, found under the five main menus. See Table 7-2.

Menu	Tab	Function Descriptions
Exit		<ul style="list-style-type: none">• Exit the StimRouter software.• Log off the StimRouter software.
Patients		<ul style="list-style-type: none">• Open a patient record in online mode.• Open any patient record in offline mode.• Remove a patient record in offline mode.• Add a new patient in online mode.• Modify a patient name in online mode.

Menu	Tab	Function Descriptions
Programs	Stim Settings	<ul style="list-style-type: none"> • Program, test and save waveform, phase duration, pulse rate and intensity settings in online mode. • Turn on Efficiency Mode feature. • View stimulation settings for each program saved. • Add/delete programs in online mode. • Print/save the selected program.
	Time Settings	<ul style="list-style-type: none"> • Program, test and save time on, time off, ramp up, total time and intensity settings in online mode. • View time settings for each program saved. • Add/delete programs in online mode. • Print/save the selected program.
History	Usage	<ul style="list-style-type: none"> • View/print/save a usage log.
	Sessions	<ul style="list-style-type: none"> • View/print/save a session history.
Tools	Info	<ul style="list-style-type: none"> • View system information in online mode. • Reset the Patient Programmer and EPT in online mode.
	Users	<ul style="list-style-type: none"> • Add a new user. • Remove a user. • Change a user password.
	Backup	<ul style="list-style-type: none"> • Back up the Clinician's Programmer database. • Enable/disable automatic database backup.
	Restore	<ul style="list-style-type: none"> • Restore the Clinician's Programmer database from automatic backup. • Restore the Clinician's Programmer from manual backup.

Table 7-2: StimRouter software navigation menus, navigation tabs and functions that can be performed from each menu/tab

Navigation Buttons

When pressed, a navigation button will open a new screen or execute a command. Depending on the operating mode, a button may be enabled or disabled. Disabled buttons are GRAY. For a list of commonly used buttons, see Table 7-3.

Button	Function Descriptions
?	<ul style="list-style-type: none"> • Open help screens.
Change Password	<ul style="list-style-type: none"> • Change a user password (enabled for administrators only).
Clear	<ul style="list-style-type: none"> • Delete characters in a field.
Exit	<ul style="list-style-type: none"> • Exit the StimRouter software.
Login	<ul style="list-style-type: none"> • Log into the StimRouter software.
Log Off	<ul style="list-style-type: none"> • Log off the StimRouter software.
Modify	<ul style="list-style-type: none"> • Modify an existing patient record.
New	<ul style="list-style-type: none"> • Add a new patient record.
New User	<ul style="list-style-type: none"> • Add a new user (enabled for administrators only).
Open	<ul style="list-style-type: none"> • Open an existing patient record.
Print	<ul style="list-style-type: none"> • Print the specified report to a standard printer.
Save	<ul style="list-style-type: none"> • Save the specified report to a file in .csv format (excel).
Remove	<ul style="list-style-type: none"> • Remove an existing patient record.
Remove User	<ul style="list-style-type: none"> • Remove a user (enabled for administrators only).
Reset Patient Programmer	<ul style="list-style-type: none"> • Resets the Patient Programmer so that it can be transferred from one EPT to another.
Reset the System (Patient Programmer and EPT)	<ul style="list-style-type: none"> • Restore factory settings on the Patient Programmer and EPT. (When selected, all patient data on the Patient Programmer and EPT are erased.)
Stop & Save	<ul style="list-style-type: none"> • Stop stimulation and save the stimulation and time settings.
Test	<ul style="list-style-type: none"> • Test the current stimulation and time settings.
View	<ul style="list-style-type: none"> • View session details.

Table 7-3: Selected navigation buttons and their accompanying functions

Intensity Level Bar

Used to adjust stimulation intensity. Can be adjusted while stimulation is on or off. See Figure 7-6.

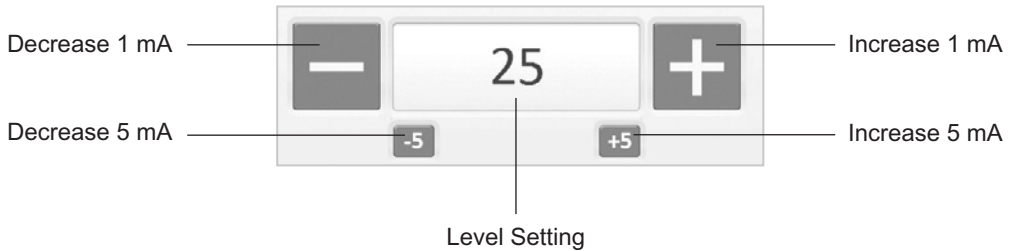

Figure 7-6: Intensity level bar

Program Bar

Used to add, delete and view up to eight clinician-set stimulation programs, labeled A-H. See Figure 7-7.



Figure 7-7: Program bar and icon definitions

Add Program Icon. Used to add a new stimulation program. Enabled in online mode when fewer than eight programs have been saved.

Delete Program Icon. Used to delete a stimulation program. Enabled in online mode when more than one program has been saved.

Program Bar Arrows. Used to scroll through the saved programs. Enabled when more than one program has been saved.

Search Bars

Used to search the clinician programmer database. See Figure 7-8.

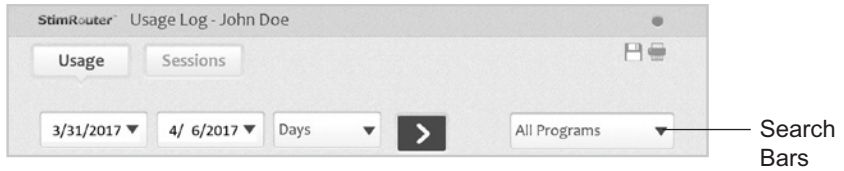

Figure 7-8: Search bars for usage log

Stimulation Parameters

Patients require tailored stimulation patterns to help control their pain. The StimRouter system features eight programmable parameters and can store up to eight stimulation programs on the Clinician’s Programmer, Patient Programmer and EPT. Timing parameters are specified in Table 7-4. Pulse parameters are specified in Table 7-5.

Timing Parameter	Definition	Specification
On Time	Time that stimulation is applied per cycle	1-60 seconds, 1 second resolution
Off Time	Time that stimulation is turned off per cycle	1-60 seconds, 1 second resolution (0 seconds = constant stimulation)
Ramp Up Ramp Down	Time to increase stimulation from zero to the set intensity Time to decrease stimulation from zero to the set intensity Note: Ramp up and ramp down are always identical.	0-10 seconds, but not more than “On Time”/2, with 1 second resolution 0-10 seconds, but not more than “On Time”/2, with 1 second resolution
Total Time	Duration from the initiation to the end of a stimulation program	10 minutes-12 hours
Constant Stimulation	Stimulation is constant when “Constant Stim” box is checked.	N/A

Table 7-4: Timing parameters

Pulse Parameter	Specification
Pulse	Balanced biphasic (pulse is hardware balanced — no DC component exists)
Waveform	Symmetric or Asymmetric
Intensity*	0-30 milliamperes peak, 1 milliampere resolution (positive phase)
Maximum Voltage	100V
Maximum Output	12 milliamperes root mean square
Maximum Charge	15 microcoulombs per phase
Electrode Current Density	Less than 1 milliampere root mean square per centimeter square
Positive Phase Duration**	70, 100, 150, 200, 250, 300, 350, 400, 450, 500 microseconds
Negative Phase Duration	Symmetric: Identical to the positive phase duration. Asymmetric: Four times the positive phase duration.
Total Pulse Duration	Up to 2500 microseconds (depends on waveform)
Maximum Load	5000 ohms (subject to max voltage limitation) in parallel to 80 nanofarads
Typical Load	2700 ohms in parallel to 22 nanofarads
Minimum Load	100 ohms in parallel to 1 nanofarad
Pulse Repetition Rate***	1, 2, 5, 10, 12, 15, 20, 30, 40, 50, 60, 70, 80, 90, 100, 120, 140, 160, 180, 200 hertz
LED	Green light LED indication: <ul style="list-style-type: none"> • Constant while charging • 2Hz blinking at end of battery charge

*Intensity: A measure of strength of the stimulation.

**Positive phase duration: A measure of the duration of a pulse.

***Pulse repetition rate: The number of times per second a pulse is delivered.

Table 7-5: Pulse parameters

Clinician's Programmer Set-Up

Connecting the Clinician's Programmer and Programmer Connector Cable

To connect the Clinician's Programmer and Programmer Connector Cable:

1. Plug the Programmer Connector Cable into the connector port on the Clinician's Programmer.

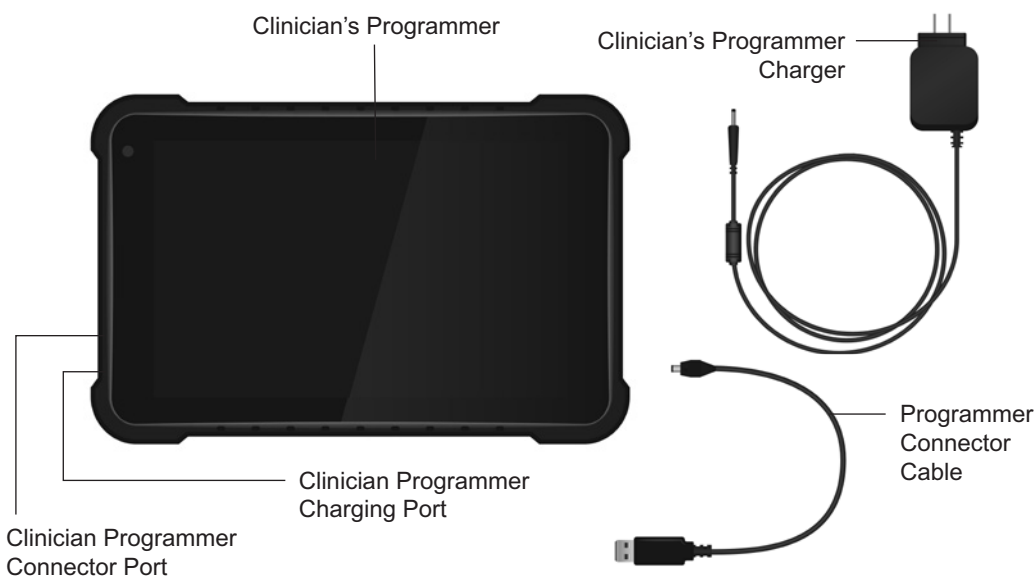

Figure 8-1: The Clinician's Programmer set-up

Charging the Clinician's Programmer

To charge the Clinician's Programmer:

1. Insert the Clinician Programmer Charger into the Clinician Programmer charging port and plug the charger into a power socket. Plug the charger into a power socket. See Figure 8-1.

⚠ WARNING: Use only the Clinician’s Programmer charger included in the StimRouter Clinician Kit.

Connecting the Patient Programmer and Programmer Connector Cable

To connect the Patient Programmer and programmer connector cable:

1. Open the flexible cover on the Patient Programmer.
2. Plug the Programmer Connector Cable into the connector port of the Patient Programmer. See Figure 8-2.

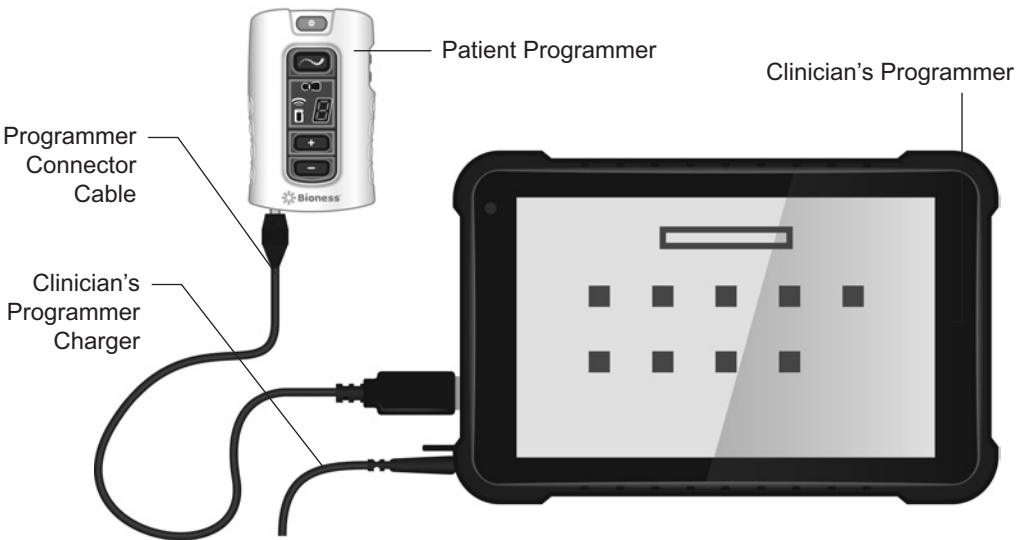

Figure 8-2: Patient Programmer connection configuration

Logging into the StimRouter Software

To log into the StimRouter software:

1. Turn the Clinician’s Programmer on by pressing the on/off button on the upper left corner of the Clinician’s Programmer.
2. If the login screen does not open automatically, then, press “Start” and then “StimRouter” to open the StimRouter software. Wait for the login screen to load. See Figure 8-3.



Figure 8-3: The StimRouter software login screen

3. To log in, enter a user name and password, and then press the “Login” button.

Note: Always log off the StimRouter software before leaving the Clinician’s Programmer unattended.

Software Records and History

Patient Records

This section reviews how to add, copy, open, modify, remove and search for a patient record; and how to view, print and save a patient's session and usage history.

Adding a New Patient

Follow these instructions when a patient does not have a record in the Clinician's Programmer database and no data has been stored on the EPT and Patient Programmer. The patient is new and their system is unassigned.

To add a new patient to the Clinician's Programmer database:

1. Connect the Patient Programmer to the Clinician's Programmer.
2. Connect the patient's EPT to a StimRouter Electrode. See "Connecting the StimRouter Electrode and EPT" section of this guide.
3. If the EPT and Patient Programmer are unassigned, then the software should automatically prompt that no patient data was found on the system. Press the "OK" button. See Figure 9-1.

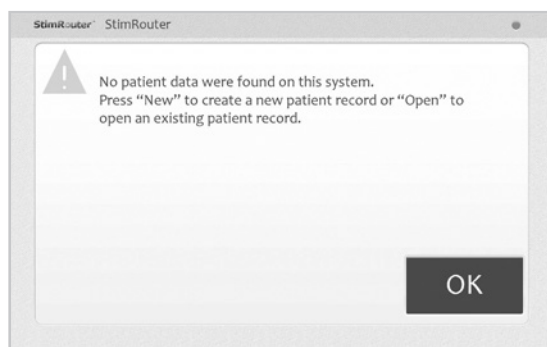

Figure 9-1: Unassigned system detected

4. If this prompt does not appear and the patient's components are new, then reset the Patient Programmer and EPT. See "Resetting the Patient Programmer and EPT" section of this guide.
5. Press "New" to create a new patient record.
6. When the New Patient window opens, enter the patient's first and last names and a patient ID. See Figure 9-2.

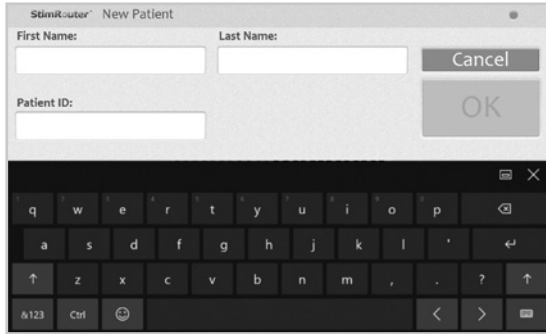

Figure 9-2: New patient window

7. Proceed to the "Patient Set-Up and Programming Instructions" chapter of this guide.

Copying a Record for an Existing Patient to an Unassigned System

Follow these instructions when a patient has a record stored in the Clinician's Programmer database and no patient data has been stored on the EPT or Patient Programmer. This patient may have purchased replacement components, or the patient's components may have been reset.

To copy a record for an existing patient to an unassigned system:

1. Connect the Patient Programmer to the Clinician's Programmer.
2. Connect the patient's EPT to a StimRouter Electrode. See "Connecting the StimRouter Electrode and EPT" section of this guide.
3. If the EPT and Patient Programmer are unassigned, then the software should automatically prompt that no patient data was found on the system. Press "OK". See Figure 9-1.
4. From the Patient List window, select the patient's record and press "Open". When the patient record opens, the patient data will automatically copy from the Clinician's Programmer to the EPT and Patient Programmer.

Adding a Patient with an Assigned System

Follow these instructions when a patient does not have a record in the Clinician's Programmer database, but data has been stored on the patient's EPT and Patient Programmer. This patient may be a referral from another clinic or from a physician using a different Clinician's Programmer.

To add a patient with an assigned system to the Clinician's Programmer database:

1. Connect the Patient Programmer to the Clinician's Programmer.
2. Connect the patient's EPT to a StimRouter Electrode. See "Connecting the StimRouter Electrode and EPT" section of this guide.
3. The StimRouter software will automatically prompt that a new patient was found and to add the patient to the clinician programmer database. Press "OK". See Figure 9-3.
4. Proceed to the "Patient Set-Up and Programming Instructions" chapter of this guide.

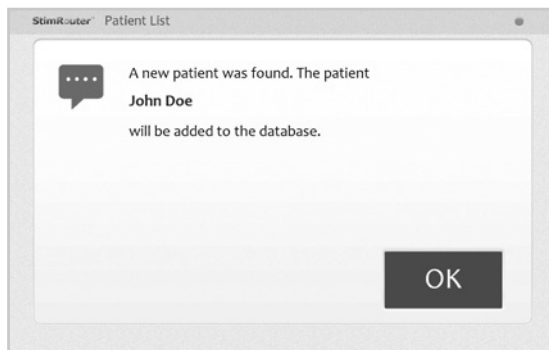

Figure 9-3: Adding a patient with an assigned system

Opening a Patient Record

Note: When the Clinician's Programmer is in online mode and connected to an assigned Patient Programmer and an EPT, then only the patient record corresponding to those components can be opened. If the Clinician's Programmer is in offline mode, then any patient record can be opened and viewed.

To open a patient record:

1. From the Patient List, select a patient and press the "Open" button. See Figure 9-4.

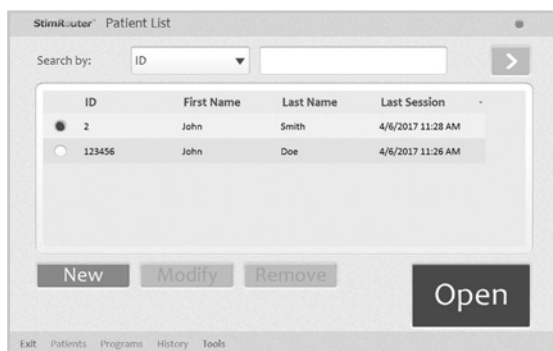

Figure 9-4: Opening a patient record

Modifying a Patient Record

Note: “Modify” is only enabled in online mode, when the Clinician’s Programmer is connected to a working Patient Programmer and EPT.

To modify a patient record:

1. From the Patient List, press the “Modify” button.
2. Enter changes to the patient’s first or last name, and then press the “OK” button. See Figure 9-5.

Note: The Patient ID cannot be modified.

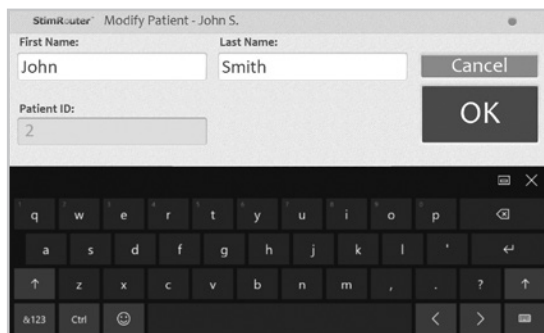

Figure 9-5: Modifying a patient record

Removing a Patient Record

Note: “Remove” is only enabled in offline mode.

To remove a patient record:

1. Make certain that the Clinician's Programmer is not connected to an operational Patient Programmer and EPT.
2. From the Patient List select the patient record to remove, and then press the "Remove" button. See Figure 9-6.
3. Press the "Yes" button in the Remove Patient window.



Figure 9-6: Removing a patient record

Searching for a Patient Record

To search for a patient record:

1. Make certain that the Clinician's Programmer is not connected to an operational Patient Programmer and EPT.
2. From the Patient List select the "Search by" drop-down list and pick a search criterion.
3. Enter the search data in the accompanying field, and then press the double arrow to start the search.
4. The first match found (if any) will be highlighted on the Patient List.
5. Press the double arrow again to view any additional matches found.

Usage History

The patient usage history is stored on the EPT and is automatically retrieved when the Clinician's Programmer is connected to an operational Patient Programmer and EPT.

Viewing a Usage History

To view a usage history:

1. From the Patients List, select a patient and press the “Open” button.
2. Press “History” on the Menu Bar and then press the Usage Tab to open the Usage Log.
3. In the “Display” drop-down list (bottom right of screen), select a program to view or select “All Programs.” See Figure 9-7.

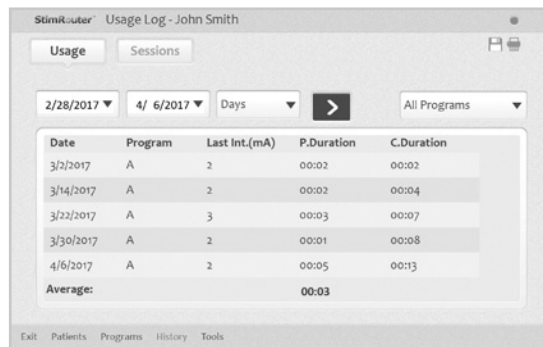

Date	Program	Last Int.(mA)	P.Duration	C.Duration
3/2/2017	A	2	00:02	00:02
3/14/2017	A	2	00:02	00:04
3/22/2017	A	3	00:03	00:07
3/30/2017	A	2	00:01	00:08
4/6/2017	A	2	00:05	00:13
Average:			00:03	

Figure 9-7: Sample usage log for program A

4. In the drop-down lists (top of screen), select a from date, a to date and an interval for viewing, then press the double arrow. The usage history will open.

Note:

Last Int. - Intensity in mA when system was turned off the last time that interval.

P. Duration - Program duration. How long the program was used in that interval.

C. Duration - Cumulative duration. The total of the program durations.

Average - Average of the program duration per interval.

Printing/Saving a Usage History

To print a usage history:

1. Press the print icon on the Usage Log window.
2. Windows Standard print dialog will appear.

To save a usage history:

1. Press the save icon on the Usage Log window.

2. Windows folder selection dialog will appear, select a folder where the file will be saved. Press OK to save.

Session History

Viewing a Session History

To view a session history:

1. From the Patients List, select a patient and press the “Open” button.
2. Press “History” on the Menu Bar and then press the Sessions Tab, select a session to view, and then press “View” button. See Figure 9-8.

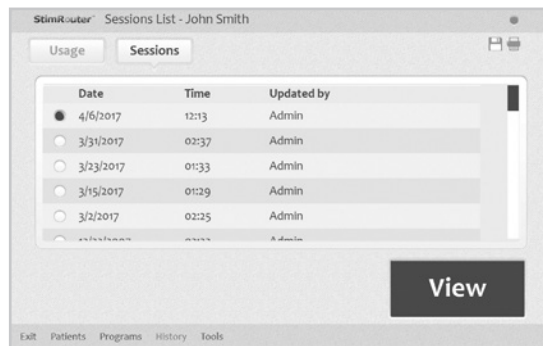

Figure 9-8. Viewing a session.

3. The session detail will open. See Figure 9-9.

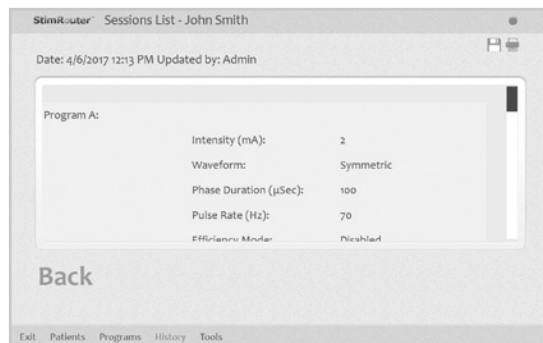

Figure 9-9. Session detail window

Printing/Saving a Session History

To print a session history:

1. With the session detail window open, press the print icon.
2. Windows standard print dialog will appear.

To save a session history:

1. Press the save icon on the Usage Log window.
2. Windows folder selection dialog will appear, select a folder where the file will be saved. Press “OK” to save.

Printing/Saving Multiple Sessions

To print multiple sessions:

1. Press the Sessions Tab.
2. Press the print icon.
3. When the Print Sessions screen opens, check the box next to each session to be printed, then press the “Print” button. See Figure 9-10.
4. Windows standard print dialog will appear.

To save multiple sessions:

1. Press the Sessions Tab.
2. Press the save icon.
3. When the Save Sessions screen opens, check the box next to each session to be printed, then press the “save” button.
4. Windows folder selection dialog will appear, select a folder where the file will be saved. Press “OK” to Save.

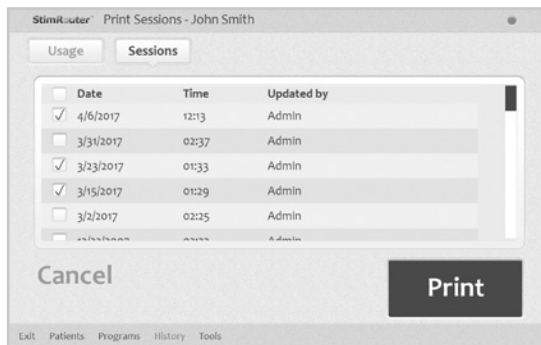

Figure 9-10. Printing multiple sessions

Patient Set-Up and Programming Instructions

Preparing the Patient's Skin

To prepare the skin:

1. Clean the skin where the StimRouter Electrode will adhere with a wet washcloth. If any lotions or oils are on the skin, then clean with soap and water. Rinse well and dry.
2. If necessary, remove excess body hair from the skin area using scissors. Do not use a razor because it can irritate the skin.
3. Always check the skin for redness or a rash.

Connecting the StimRouter Electrode and EPT

To connect the StimRouter Electrode and EPT:

1. Obtain a new StimRouter Electrode.
2. Check the "Use by" date on the StimRouter Electrode box.
3. Do not remove the liner at this time. Set the StimRouter Electrode on a flat surface with the gel pads facing down.
4. Snap the EPT onto the StimRouter Electrode. See Figure 10-1.

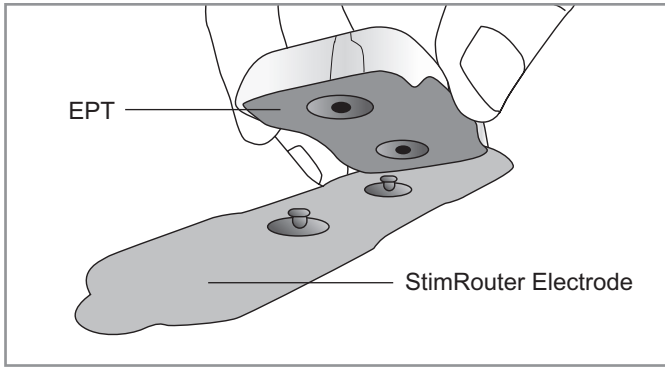

Figure 10-1: StimRouter Electrode and EPT connecting

Adhering the StimRouter Electrode to the Skin

⚠ WARNING: Do not touch the gel pads of the StimRouter Electrode with both hands while stimulation is turned on. Serious injury could result from electrical current passing across the chest cavity. Stimulation should be turned off before adhering, removing or handling the StimRouter Electrode.

To adhere the StimRouter Electrode:

1. Remove the liner and store it in the StimRouter Electrode Carrying Case. See Figure 10-2.

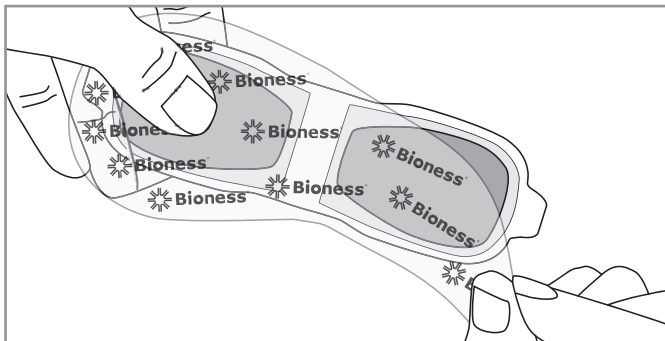

Figure 10-2: Remove the StimRouter Electrode Liner

2. Visually inspect the gel pads on the back of the StimRouter Electrode. Make sure the gel is smooth and the gel pads are not dry, worn or dirty.
3. Using the index finger and thumb, grasp the edges of the EPT attached to the StimRouter Electrode so the gel pads face downward. See Figure 10-3.



Figure 10-3: Grasp the edges of the EPT attached to the StimRouter electrode

4. Align the end of the StimRouter electrode with the EPT charging port directly over the receiver end of the lead. The center of the gel pad should be above the receiver end of the lead. See Figure 10-4. If the StimRouter electrode is not directly over the receiver end of the lead, then stimulation may be uncomfortable or ineffective.

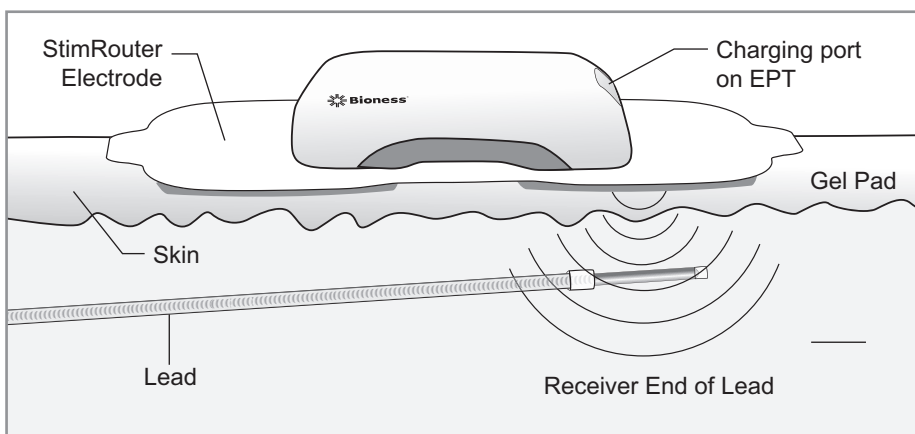

Figure 10-4: Optimal stimulation, position (Illustration not to scale)

Note: The effectiveness of the stimulation is sensitive to the alignment and rotation of the StimRouter electrode in relation to the receiver end of the lead. If the alignment of the StimRouter electrode changes, the stimulation intensity may need to be adjusted.

5. Position the other end of the StimRouter electrode where it will minimize discomfort and avoid muscle contractions.

! **CAUTION:** Do not pinch or stretch the skin while adhering the StimRouter electrode.



CAUTION: Make certain the adhesion site is free of obstructions (for example, bandages, clothing, etc.) before adhering the StimRouter Electrode. If the StimRouter Electrode is placed partially or wholly over a bandage or other obstruction, then skin irritation or tissue damage could occur during stimulation.

6. Firmly adhere the StimRouter Electrode to the skin, making sure that the electrode is in full contact with the skin. If the StimRouter Electrode is not firmly adhered to the skin and moves, then stimulation may become uncomfortable or ineffective.
7. Make certain that the patient programmer is within 10 feet (3 meters) of the StimRouter Electrode with EPT attached.

Confirming Set-Up

If the Clinician's Programmer, Patient Programmer, EPT and StimRouter Electrode are connected correctly, the Clinician's Programmer information icon will be GREEN, confirming online mode.

To confirm the clinician programmer is in online mode:

1. Check that the information icon on the clinician programmer is GREEN. 
2. If the information icon is not GREEN, make certain that the StimRouter Electrode with the EPT attached is within 10 feet (3 meters) of the Patient Programmer.
3. If the information icon is still not GREEN, check all connections, charge the Patient Programmer and EPT.
4. Test the EPT using the tester.
5. See the "Troubleshooting" section of this guide.

Refer to the StimRouter User's Guide for detailed operational instructions for the StimRouter Patient Programmer, EPT and StimRouter Electrode.

Removing the StimRouter Electrode

To remove the StimRouter Electrode:

1. Make certain that stimulation is turned off. Then grasp the tab on the StimRouter Electrode and gently pull away from the skin. See Figure 10-5.

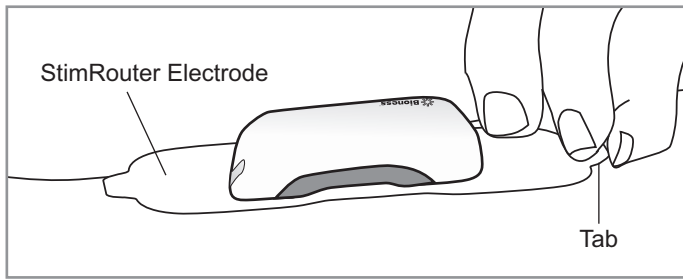

Figure 10-5: Removing the StimRouter Electrode

2. Attach the StimRouter Electrode liner to the gel pads. Without the liner attached, the gel pads on the back of the StimRouter Electrode will lose their adhesiveness.
3. Store the StimRouter electrode with the liner attached in the StimRouter Electrode carrying case.

Programming Instructions

This section describes how to program stimulation and time settings, and how to add a program, view a program, delete a program, save a program, and print a program.

Programming Stimulation Settings

To program stimulation settings:

1. Make sure that the StimRouter software is in online mode (the information icon should be GREEN). See “Confirming Set-Up” section of this guide.
2. From the Patients List, select a patient and press “Open”. The Stim Settings window will open. See Figure 10-6.

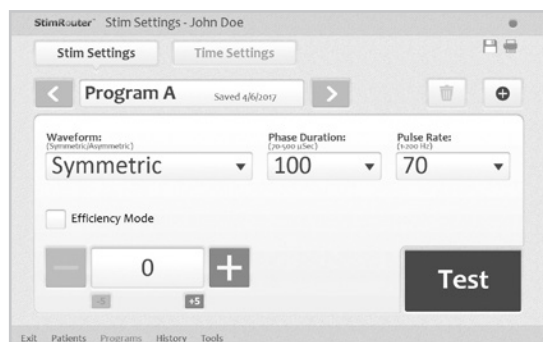

Figure 10-6: Stim Settings window

3. Press the “Test” button to test the stimulation settings; stimulation will turn on.
4. If needed, adjust the stimulation settings using the drop-down lists next to “Waveform”, “Phase Duration”, and “Pulse Rate”.

Note: The stimulation settings have a constant ramp-up and ramp-down of 1 second, during which the patient may not feel any stimulation. Account for ramp-up and ramp-down time during the adjustment process.

Note: Efficiency mode is used to save battery power, but this mode does change the sensation of the stimulation. Efficiency mode may be considered being turned on to help maximize battery consumption with heavy users.

5. Slowly increase the intensity to a level that is tolerable for the patient and achieves paresthesia.

Note: If the combination of parameters or intensity level exceeds the maximum allowed, then a warning will appear with directions to reduce the stimulation. The “Test” button will be disabled. See Figure 10-7.

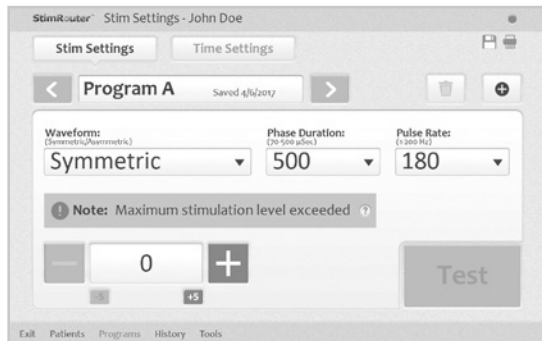

Figure 10-7: Maximum charge level exceeded

6. Press the “Stop & Save” button to stop stimulation and save the stimulation settings to the Clinician’s Programmer, Patient Programmer and EPT. See Figure 10-8.

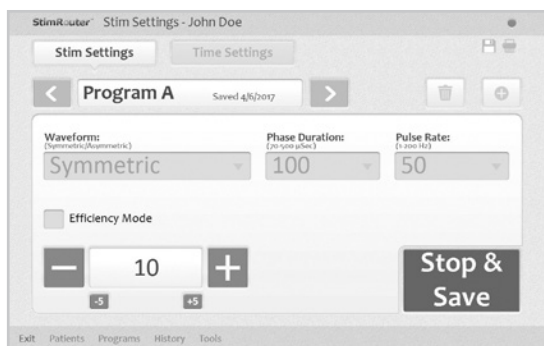

Figure 10-8: Press “Stop & Save” to stop testing and save the current stimulation settings

7. The program save date will appear on the Program Bar.

Programming Time Settings

To program time settings:

1. From the Stim Settings window, press the Time Settings Tab.
2. The default time setting is constant stimulation. When “Constant Stim” is checked, “Time On” and “Time Off” are disabled; “Ramp Up/Ramp Down” and “Total Time” can be adjusted. See Figure 10-9. To change the “Time On” and “Time Off” settings, uncheck “Constant Stim” box and adjust “Time On” and “Time Off” using the drop-down lists.

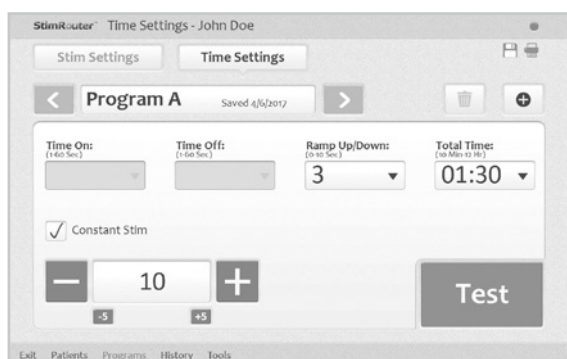

Figure 10-9: Time Settings window

3. Press the “Test” button to test the time settings; stimulation will turn on.
4. If needed adjust the intensity level.
5. Press the “Stop & Save” button to stop stimulation and save the time settings to the Clinician’s Programmer, Patient Programmer and EPT.
6. The program save date will appear on the Program Bar.

Programs

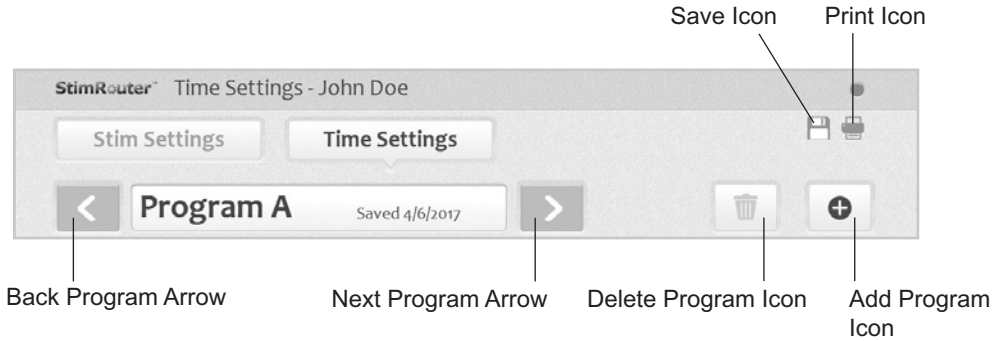

Figure 10-10: Program icons on the program bar

Adding a Program

To add a program:

1. From the Stim Settings Window or Time Settings Window press the add program icon on the Program Bar. See Figure 10-10.
2. The new program Stim Settings window will open with default settings. The StimRouter software can support up to eight stimulation programs, labeled (A-H) which will appear in the Program Bar.
3. Program the settings, test the settings and press the “Stop & Save” button to save the new settings.
4. The new program will be saved to the Clinician’s Programmer database, the Patient Programmer and the EPT.

Note: The StimRouter software must be in online mode to add a program.

Saving a Program

To save a program to file:

1. From the Stim Settings Window or Time Settings Window press the Save program icon on the Program Bar. See Figure 10-10.
2. Select a folder from the windows folder browser dialog press the “OK” button.

Deleting a Program

To delete a program:

1. From the Stim Settings Window or Time Settings Window, select a program to delete.
2. Press the delete program icon on the Program Bar. See Figure 10-10.

Note: The StimRouter software must be in online mode to delete a program.

Printing a Program

To print a program:

1. From the Stim Settings Window or Time Settings Window, select a program and press the print icon on the Program Bar. See Figure 10-10.
2. Select a printer from the printing dialog, and then press the “OK” button. See Figure 10-11.

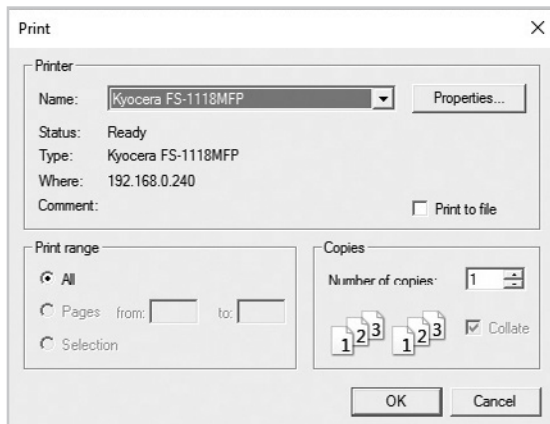

Figure 10-11: Print a program window

Software Tools

Resetting the Patient Programmer and EPT

System information can be found on the Info Tab of the Tools Menu. From the Info Tab users can look up the installed software version on all components of the StimRouter system. For example, “EPT SW VER: 1.0.0.4” indicates to the user that the EPT software version is 1.0.0.4.

Users can reset the Patient Programmer, if, for example, a clinic Patient Programmer is to be used. Users can also reset both the Patient Programmer and the EPT, which restores the components to their factory settings. All patient data and logs are deleted.

To reset the Patient Programmer:

1. Connect the Patient Programmer to the customized adapter cable to tablet.
2. Press “Tools” on the Menu Bar, then press the Reset Tab. See Figure 11-1.

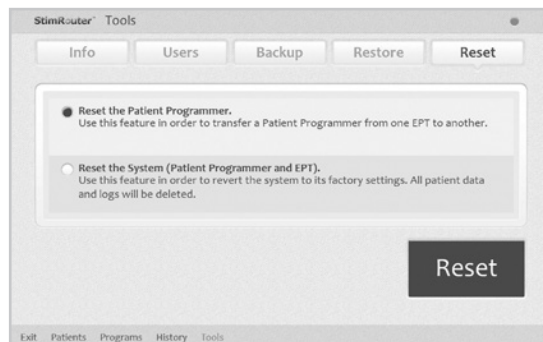

Figure 11-1: Resetting the Patient Programmer and EPT

3. To reset **only the Patient Programmer**, select “Reset the Patient Programmer,” and then press “Reset” button.
4. To reset **both the Patient Programmer and EPT**, select “Reset the System (Patient Programmer and EPT)”, and then press the “Reset” button.

User Administration

The StimRouter software supports two levels of users: users and administrators. Both users and administrators have access to the Info Tab of the Tools Menu. Administrators have extended authorizations and have access to the Users, Backup and Restore tabs of the Tools Menu. Administrators can define automatic backup options, manually back up the Clinician’s Programmer database, manually restore the Clinician’s Programmer database, add and remove users/administrators, and change user passwords.

Adding a User/Administrator

To add a user/administrator:

1. Press “Tools” on the Menu Bar, press the Users Tab and then press the “New User” button. See Figure 11-2.
2. Enter a user name and password, confirm the password, select either “Users” or “Administrators” from the “Group” drop-down list, and then press the “Add” button. See Figure 11-3.

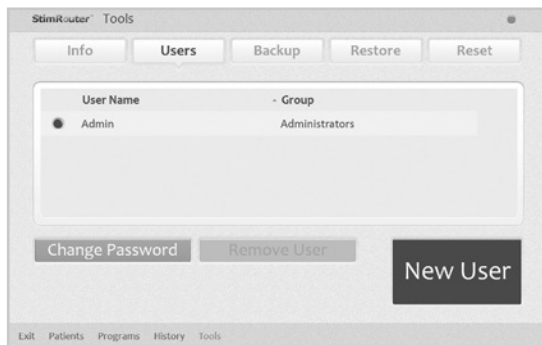

Figure 11-2: Adding a user/administrator

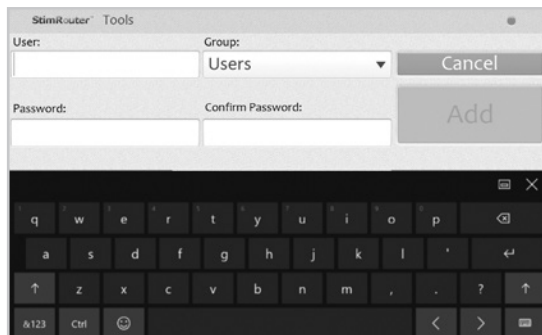

Figure 11-3: Add new user window

Removing a User/Administrator

To remove a user/administrator:

1. Press “Tools” on the Menu Bar, press the Users Tab, select a user name, and then press the “Remove User” button. Confirm “Yes” or “No” when prompted. See Figure 11-4.

Note: The administrator who is logged on cannot be removed.

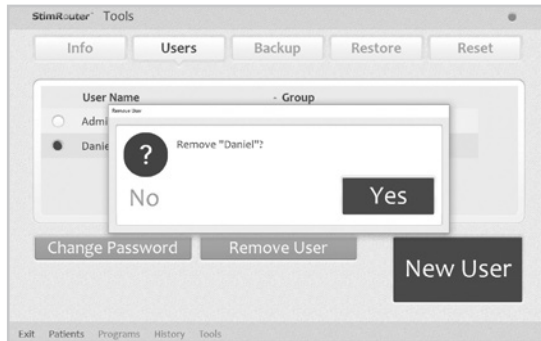

Figure 11-4: Removing a user

Changing a User Password

To change a user password:

1. Press “Tools” on the Menu Bar, press the Users Tab, select a user name, and then press the “Change Password” button.
2. Enter and confirm the new user password, and then press the “OK” button.

Note: Bioness recommends passwords be changed at least every three months.

Clinician’s Programmer Database Backup and Restore

Administrators can back up the Clinician’s Programmer database to the memory card automatically or manually at any time. When a memory card is installed and automatic backup is enabled, the Clinician’s Programmer will automatically back up the database periodically and whenever the StimRouter software is exited.

Enabling Automatic Database Backup

To enable automatic database backup:

1. Press “Tools” on the Menu Bar, press the Backup Tab, and then check “Enable automatic database backup”. The Clinician’s Programmer database will back up once daily and each time the software is exited. See Figure 11-5.

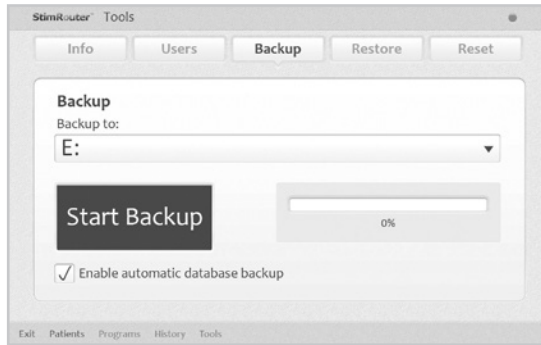

Figure 11-5: Backing up the Clinician’s Programmer database

Manually Backing Up the Database

To manually back up the Clinician’s Programmer database:

1. Press “Tools” on the Menu Bar and then press the Backup Tab.
2. From the “Back up to” drop-down list, select SD Card drive, and then press the “Start Backup” button. See Figure 11-5.

Restoring the Database

Administrators can restore the database when the Clinician’s Programmer is replaced or the database is corrupted.

To restore the Clinician’s Programmer database:

1. Insert the memory card with the backup files into Clinician’s Programmer.
2. Press “Tools” on the Menu Bar and then press the Restore Tab.
3. From the “Restore from” drop-down list, select SD Card drive. See Figure 11-6.

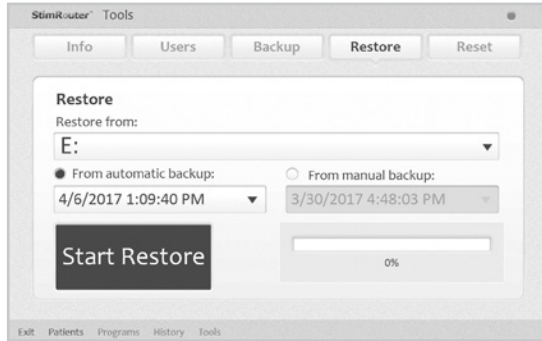

Figure 11-6: Restoring the Clinician's Programmer database

4. Select "From automatic backup" or "From manual backup", and then choose a backup date and time from the drop-down lists.
5. Press the "Start Restore" button.

Maintenance and Cleaning

Replacing the StimRouter Electrode

The typical lifespan of the StimRouter Electrode is two to four days, depending on:

- The number of hours of use.
- The number of times the electrode is adhered to and removed from the skin.
- Hygiene and skin care in the area of StimRouter Electrode placement.

To ensure maximum StimRouter Electrode lifespan and performance, always attach the electrode liner to the gel pads when storing the StimRouter Electrode.

Instruct patients to dispose of the StimRouter Electrode when any of the following occurs:

- The gel pads start to peel off at the edges or detach from the StimRouter Electrode.
- The gel pads appear worn or dirty.
- The gel pads lose their adhesiveness.
- After a maximum of four days of use.

Replacing the Patient Programmer Battery

The Patient Programmer battery should be replaced approximately every two years.

 **WARNING:** Use only a rechargeable 1.2-volt NiMH AAA battery (900, 1000 or 1100 milliampere-hours). A non-rechargeable battery can damage and overheat the Patient Programmer. Overheating may lead to tissue injury or burns.

To replace the battery: See Figure 12-1

1. Remove the label on the back of the Patient Programmer. The label covers a small screw.

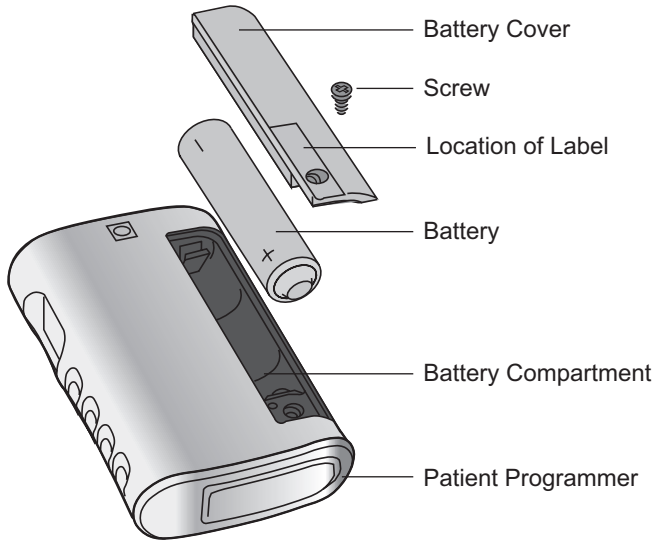

Figure 12-1: Replacing the patient programmer battery

2. Remove the screw and battery cover. Remove the old battery.
3. Insert a new rechargeable AAA NiMH 1.2-volt battery (900, 1000 or 1100 milliampere-hours). Align the +/- marks with those on the battery compartment.
4. Reattach the battery cover and tighten the screw.
5. Replace the label.
6. Fully charge the new battery before first use.



Properly dispose of the old battery according to your local environmental regulations.

Cleaning

All StimRouter Clinician Kit components may be cleaned by carefully wiping them with a damp cloth using water only. Do not use detergents or other cleaning agents. Do not clean the gel pads on the back of the StimRouter Electrode.

The screen of the Clinician Programmer can be cleaned using any commercially available screen cleaner for liquid crystal displays (LCD) and computer screens.

Note: StimRouter electronic components are not waterproof; do not immerse them in water.

Disinfecting

Electronic Components

All StimRouter Clinician Kit electronic components may be cleaned and low-level disinfected using CaviWipes™ (if available), or wipes or cloths saturated (but not dripping) with 70% isopropyl alcohol (IPA) per the instructions below:

1. Use one saturated disinfectant wipe or cloth to thoroughly wet the component surface.
2. Use a second saturated disinfectant wipe or cloth to remove any surface contaminants. Soil, etc., will impede the disinfectant's effectiveness, if not removed.
3. As needed, use additional saturated disinfectant wipes or cloths to keep the component surface wet for 10 minutes.

Note: Be sure to follow the Bioness instructions for the specified contact time to ensure an effective bacteria kill.

Troubleshooting

The tables at the end of this section describe the visual indicators that may appear on the Clinician's Programmer and Patient Programmer, and possible solutions for troubleshooting. In addition, this section describes solutions for the following scenarios that may arise during a programming session:

- The patient forgets to bring the Patient Programmer.
- The patient forgets to bring or has lost the EPT.
- The patient brings a new Patient Programmer and EPT.

Patient Forgets Patient Programmer

If a patient forgets to bring his or her Patient Programmer to a follow-up session, an alternate "clinic" Patient Programmer can be used. The clinic Patient Programmer must be reset and then registered to the patient's EPT to proceed. Once the clinic's Patient Programmer and patient's EPT are registered, patient data stored on the EPT can be retrieved by the Clinician's Programmer and new data can be stored on the EPT.

The patient will need to re-register his or her EPT and Patient Programmer later. The new data stored on the EPT will overwrite the data stored on the Patient Programmer.

Note: The information stored on an EPT will always overwrite the information stored on a Patient Programmer.

Using a Clinic Patient Programmer

To use a clinic Patient Programmer:

1. Connect the clinic Patient Programmer to Programmer Connector Cable.
2. Make sure the EPT and the Patient Programmer are charged, if not connect them to a charger.

3. Make sure the Patient Programmer and the EPT are no more than a few inches apart and not touching.
4. Make certain that any other clinic EPT is at least 10 feet (3 meters) away from the components to be registered.
5. Press “Tools” on the Menu Bar and then press the Reset Tab.
6. Select “Reset the Patient Programmer” and press the “Reset” button.
7. The StimRouter software will detect the unregistered Patient Programmer and ask whether you want to register this Patient Programmer to an EPT now. See Figure 13-1.

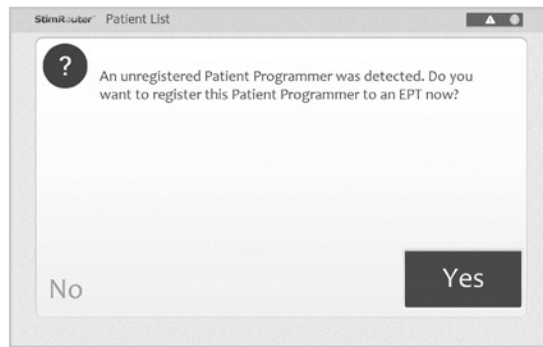

Figure 13-1: Unregistered Patient Programmer detected

8. Press the “Yes” button.
9. Once the Patient Programmer and EPT are registered, press the “OK” button.
10. From the Patient List, select the patient and press “Open” to open the patient’s record.

Note: The patient Usage Log is stored on the EPT and is automatically retrieved when the Patient Programmer and EPT are connected.

11. Proceed with the programming session. Programming changes will be automatically saved to the EPT.
12. Before the session ends, remind the patient to re-register his or her EPT and Patient Programmer at home. Review with the patient the following instructions for RF registration.

Registering the Patient Programmer/EPT

The Patient Programmer and EPT must be electronically registered to each other to operate.

To register the Patient Programmer/EPT:

1. If necessary, charge the Patient Programmer.
2. Ensure that the patient programmer is turned off (the on/off button should not be FLASHING GREEN). See Table 13-1.



Patient Programmer OFF	Patient Programmer ON
	

Table 13-1: Patient programmer on/off indicators

3. Place the Patient Programmer and EPT close together on a table. Make sure the Patient Programmer and the EPT are no more than a few inches apart and not touching.
4. Simultaneously press and hold for three seconds the mode and minus buttons on the Patient Programmer to start the registration process. See Figure 13-2. The Patient Programmer will sound an audio alert, indicating the registration process has begun.
5. The Patient Programmer digital display should show two ALTERNATING GREEN ARCHES, indicating registration is in progress.

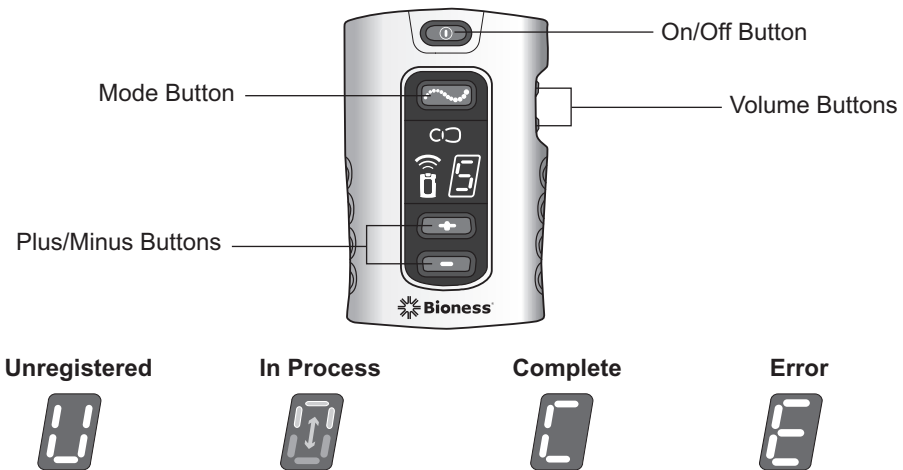

Figure 13-2: StimRouter Patient Programmer operating buttons and RF registration status indicators

6. When the digital display shows the letter “C” and the RF icon turns GREEN for a few seconds, the registration procedure is complete.

Note: If the digital display shows the letter “E” and the RF icon turns RED for a few seconds, then an error has occurred and the procedure must be repeated. If the problem persists, then reconnect the charger to the EPT. If the error indication continues to appear, see Table 13-6.

Patient Forgets EPT

If a patient forgets to bring his or her EPT to a follow-up session, reschedule the programming session. Do not substitute a clinic EPT for the patient’s EPT; only the Patient Programmer can be substituted. The information stored on an EPT will always overwrite the information stored on a Patient Programmer. If a clinic EPT is used, then the patient’s EPT will overwrite any new information stored on the Patient Programmer.

Patient Loses EPT

When a patient loses an EPT, he or she will need to obtain a new EPT and electronically register it to the Patient Programmer. See “Registering the Patient Programmer/EPT” section of this guide. All data stored on the Patient Programmer will copy to the new EPT. However, since the usage history is stored on the EPT, any usage history that was not copied to the Clinician’s Programmer database is lost with the lost EPT.

Patient Brings New EPT and New Patient Programmer

If a patient receives a replacement EPT and Patient Programmer, then the patient will need to return to the clinic to have their StimRouter system reprogrammed. The patient data stored on the Clinician’s Programmer database must be copied to the new EPT and Patient Programmer.

Copying Patient Data to New Components

To copy patient data to new components:

1. Connect the Patient Programmer to the Clinician’s Programmer.
2. Make sure the patient’s EPT and Patient Programmer are charged.
3. Make sure the Patient Programmer and the EPT are no more than a few inches apart and not touching.
4. The StimRouter software will detect the unregistered Patient Programmer and ask if you want to register this Patient Programmer to an EPT now.
5. Press “Yes”.
6. Once the Patient Programmer and EPT are registered, press “OK”.

7. From the Patient List, select the patient's record and press "Open". Once the patient record is opened, all patient data except for history will copy to the patient's new Patient Programmer and EPT.

Testing the EPT

The Tester is used to test the functionality of an EPT after the EPT has been programmed. Before connecting the EPT to the Tester, make sure the EPT is charged.

To use the Tester:

1. Connect the Tester snaps to the EPT plug holes. See Figure 13-3.

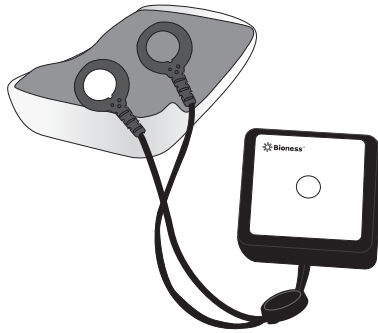

Figure 13-3: Connecting the tester to the EPT

2. Press the on/off button to turn the Patient Programmer on, and press the mode button briefly to start stimulation.

You should hear a buzzing coming from the Tester when stimulation is on and no buzzing when stimulation is off.

Troubleshooting Tables



Clinician's Programmer	Problems/Solutions
 FLASHING RED Information Icon	<p>User-Correctable Error: Faulty Electrode Contact, Radio Communication Failure</p> <ul style="list-style-type: none"> • Press the information icon to view error message and list of solutions.
 FLASHING YELLOW Information Icon	<p>Low Battery Detected: EPT or Patient Programmer</p> <ul style="list-style-type: none"> • Press the information icon to view error message and list of solutions. • Charge the Patient Programmer. • Charge the EPT.
 RED Information Icon	<p>Software or Hardware Error</p> <ul style="list-style-type: none"> • Press the information icon to view error message and list of solutions.
<p>Unexpected Error in the StimRouter Software</p>	<p>Contact Bioness or your local distributor.</p>
<p>Clinician's Programmer Will Not Turn On</p>	<ul style="list-style-type: none"> • Charge the Clinician's Programmer and verify that the charging LED is ON. • Contact Bioness or your local distributor.

Table 13-2: Troubleshooting - Clinician's Programmer

Patient Programmer Indicator	Problems/Solutions
<p>Patient Programmer Will Not Turn On</p>	<p>Battery Failure; Charger Failure; Patient Programmer Failure</p> <ul style="list-style-type: none"> • Charge the Patient Programmer. • Change the battery in the Patient Programmer. • Contact Bioness or your local distributor.

Table 13-3: Troubleshooting - Patient Programmer





EPT Icon	Problems/Solutions
 <p>EPT Icon FLASHES YELLOW</p>	<p>EPT Battery Charge Level is Low</p> <ul style="list-style-type: none"> • Charge the EPT.
 <p>EPT Icon GLOWS RED and “E” appears in the Digital Display</p>	<p>EPT Malfunction</p> <ul style="list-style-type: none"> • Contact Bioness or your local distributor.
 <p>EPT Icon FLASHES RED and “E” FLASHES in the Digital Display</p>	<p>EPT Temperature Error</p> <ul style="list-style-type: none"> • The EPT is either too hot or too cold and will cease activity until its working temperature range is restored. Restore the EPT to its working temperature range.
 <p>EPT Icon FLASHES RED and Intensity Level FLASHES in the Digital Display</p>	<p>Faulty Electrode Contact</p> <ul style="list-style-type: none"> • Turn off the Patient Programmer. • Remove the StimRouter Electrode from the skin. • Check to see that the protective covers were removed from the StimRouter Electrode. • Check to see that the EPT is correctly attached to the StimRouter Electrode. If necessary, reattach the EPT into the StimRouter Electrode. • Test the functionality of the EPT using the Tester. • Make sure that nothing is on the gel pads or on the skin that would interfere with electrode contact with the skin. • Re-adhere the StimRouter Electrode to the skin. • Replace StimRouter Electrode. • Clean the skin.

Table 13-4: Troubleshooting - Patient Programmer, EPT icon





Patient Programmer Icon	Problems/Solutions
 <p>While Charging, Patient Programmer Icon GLOWS RED and “E” Appears in the Digital Display</p>	<p>Charging Error</p> <ul style="list-style-type: none"> • Reconnect the charger cable to the Patient Programmer. • Replace the battery in the Patient Programmer.
 <p>Patient Programmer Icon GLOWS RED and “E” Appears in the Digital Display</p>	<p>Patient Programmer Malfunction</p> <ul style="list-style-type: none"> • Turn the Patient Programmer off and then back on. • Check to see if one of the buttons is stuck and, if so, try to release it. • Contact Bioness or your local distributor.
 <p>Patient Programmer Icon FLASHES YELLOW</p>	<p>Patient Programmer Battery Charge Level is Low</p> <ul style="list-style-type: none"> • Charge the Patient Programmer.

Table 13-5: Troubleshooting - Patient Programmer, Patient Programmer icon

RF Icon	Problems/Solutions
 <p>RF Icon GLOWS RED and “E” Appears in the Digital Display Immediately After the Registration Attempt</p>	<p>Registration Failure; Unknown Reason</p> <ul style="list-style-type: none"> • Retry the registration process.
<p>RF Icon GLOWS RED, and “E” and then “2” Appear in the Digital Display Immediately After the Registration Attempt</p>	<p>Registration Failure; More than One EPT Found</p> <ul style="list-style-type: none"> • Make sure only one EPT is within 10 feet of the Patient Programmer. • Re-register the components.

RF Icon	Problems/Solutions
<p>RF Icon GLOWS RED, and “E” and then “0” Appear in the Digital Display Immediately After the Registration Attempt</p>	<p>Registration Failure; No EPT Found</p> <ul style="list-style-type: none"> • Make sure the EPT is within inches of the patient programmer but not touching. • Charge the EPT. • Re-register the components.
<div data-bbox="126 707 265 852" data-label="Image"> </div> <p>RF Icon FLASHES RED</p>	<p>Radio Communication Failure or EPT Battery Failure</p> <ul style="list-style-type: none"> • Make sure the Patient Programmer and EPT are within 10 feet of each other. • If the components are within range, then turn the Patient Programmer off and back on. • Charge the EPT. • Re-register the components. • Contact Bioness or your local distributor.

Table 13-6: Troubleshooting - Patient Programmer, RF icon

EPT and Stimulation	Solutions
Stimulation Not As Effective As Usual	<ul style="list-style-type: none"> • Check the position of the StimRouter Electrode, it should be over the receiver end of the lead. • Make sure the StimRouter Electrode is securely adhered to the skin. • Visually inspect the StimRouter Electrode to make sure the gel pads are smooth and not dry. • Review the skin care instructions. Clean the skin with a damp cloth. • Change the StimRouter Electrode, if the skin is dry. • Trim hair from the StimRouter Electrode site. • Test the EPT using the tester.
Undesirable Motor Response	<ul style="list-style-type: none"> • Decrease the stimulation intensity level. • Check the placement of the StimRouter Electrode.
EPT Charging Light Does Not Turn On	<ul style="list-style-type: none"> • Check the connection. • Check the Y cable (disconnect it and connect charger directly). • Check that the charger light turns on. • Contact Bioness or your local distributor.

Table 13-7: Troubleshooting, EPT and stimulation

Incident Reporting

Any serious incident that has occurred in relation to the device should be reported to the manufacture and the competent authority of the Member State in which the user and/or patient is established if within the European Union.

Technical Specifications

Wireless (RF) Communications Specifications

Capabilities	<ul style="list-style-type: none"> • Communication between Patient Programmer and EPT
Functions	<p>RF Communication is used between the EPT and Patient Programmer, enabling the Clinician's Programmer to perform the following functions:</p> <ul style="list-style-type: none"> • Define stimulation parameters and programs (e.g., pulse width, amplitude) • Control stimulation (e.g., start/stop stimulation, change programs, adjust stimulation amplitude) • Display system status (e.g., battery charge level, error codes) • Retrieve patient stimulation session data
Modes	<ul style="list-style-type: none"> • Online Clinician Programmer mode (Clinician's Programmer connected to Patient Programmer and EPT)
Characteristics	<p>EPT and Patient Programmer</p> <ul style="list-style-type: none"> • Frequency band: 2.400 up to 2.4835 GHz • RF Frequency channels: 29 channels • Channel spacing: 580.810 kHz • Antenna type: Integrated chip antenna • Transceiver duplexing scheme: TDD • Frequency synthesizer settling time: < 1 msec • Modulation frequency: 0.5 Mbps • Modulation type: Minimum Shift Keying (MSK) • Transmit power (EIRP): EPT, -16 dBm; patient programmer, 4.1 dBm • Modulation baud rate: 500 kHz • Modulation bandwidth: 590 kHz <p>Clinician's Programmer</p> <ul style="list-style-type: none"> • Bluetooth 4.0

Locations and Ranges	<p>The Patient Programmer and EPT communicate when an object-free line of sight is available, up to 7m distance between them. The communication range will be shortened if conductive objects, such as metal or the human body, are in the communication path between the Patient Programmer and EPT. The Patient Programmer alerts visually when loss of communication with the registered EPT occurs. Intermittent RF communication may also cause some delay in user-controlled operations.</p>
Minimum Quality of Service	<ul style="list-style-type: none"> • Delay in delivery of RF command of <1 second • Packet error rate of <1%

Troubleshooting Wireless Technology

The Patient Programmer will emit audio and visual alerts if RF communication fails. See below. Report problems to Bioness or your local distributor.

Privacy of StimRouter Wireless Communication

While the frequency band used by the StimRouter wireless system can be used by other users of the band, the privacy of the StimRouter wireless system is ensured by:

- The unique ID of paired components.
- Proprietary communication protocol.
- Use of two frequency channels.
- Use of whitening function (data randomizing).

There is a risk of an interruption in the wireless communication resulting in the StimRouter system not responding to the user input.

Appendix - EMI Tables

Electromagnetic Emissions

The StimRouter system is medical electrical equipment and was tested for electromagnetic compatibility (EMC) in accordance with International Electrotechnical Committee (IEC) 60601-1-2. The following tables provide information regarding the EMC testing and guidance for safe use of the system. The StimRouter system should be configured and used in accordance with the instructions provided in this manual.

There is potential for interference between electronic devices, including cell phones and other medical devices such as a body-worn insulin pump. Stimulation control may be delayed. Maintain a minimum safe separation distance of 15 cm (6 in.) between the StimRouter system and all other electronic devices. If interference is suspected or anticipated, distance yourself from the source of interference.

Guidance and Manufacturer's Declaration Electromagnetic Emissions

The StimRouter system is intended for home use in addition to use in the electromagnetic environment specified below. The customer or the user of the StimRouter system should assure that it is used in such an environment.

 **CAUTION:** Using cables or accessories other than those supplied with the StimRouter system could result in increased emissions or decreased immunity.

Emissions Test	Compliance	Electromagnetic Environment - Guidance
RF emissions CISPR 11	Group 1	<p>The StimRouter system uses RF energy for short-range communications. Therefore, its RF emissions are very low, about 100 times lower than a commercially available cell phone. Though unlikely, portable and mobile RF communications equipment, such as the StimRouter patient programmer, EPT and clinician programmer, could affect medical electrical equipment.</p> <p>The RF-enabled components of the StimRouter system are suitable for use in all establishments, including domestic establishments and those directly connected to the public low-voltage power supply network that supplies buildings used for domestic purposes.</p>
RF emissions CISPR 11	Class B	
Harmonic emissions IEC 61000-3-2	Class A	
Voltage fluctuations/ flicker emissions IEC 61000-3-3	Complies	

Guidance and Manufacturer's Declaration Electromagnetic Immunity

The StimRouter system is intended for home use in addition to use in the electromagnetic environment specified below. The user of the StimRouter system should assure that it is used in such an environment.

Immunity Test	IEC 60601 Test Level	Compliance Level	Electromagnetic Environment - Guidance
Electrostatic discharge (ESD) IEC 61000-4-2	±6 kV contact ±8 kV air	±6 kV contact ±8 kV air	Floors should be wood, concrete or ceramic tile. If floors are covered with synthetic material, the relative humidity should be at least 30%.
Electrical fast transient/ burst IEC 61000-4-4	±2 kV for Power supply lines ±1 kV for input/output lines	±2 kV for Power supply lines Not applicable. No input/ output lines.	Mains power quality should be that of a typical commercial or hospital environment.
Surge IEC 61000-4-5	±1 kV line (s) to line(s) ±2 kV to earth	±1 kV line to line Not applicable. No grounded interconnections.	Mains power quality should be that of a typical commercial or hospital environment.
Voltage dips, short interruptions and voltage variations on power supply input lines IEC 61000-4-11	<5% U_T (>95% dip in U_T) for 0.5 cycle 40% U_T (60% dip in U_T) for 5 cycles 70% U_T (30% dip U_T) for 25 cycles <5% U_T (>95% dip in U_T) for 5 sec	<5% U_T (>95% dip in U_T) for 0.5 cycle 40% U_T (60% dip in U_T) for 5 cycles 70% U_T (30% dip U_T) for 25 cycles <5% U_T (>95% dip in U_T) for 5 sec	Mains power quality should be that of a typical commercial or hospital environment. The StimRouter system continues operation during power mains interruptions, as it is normally powered by each component battery.

Immunity Test	IEC 60601 Test Level	Compliance Level	Electromagnetic Environment - Guidance
Power frequency (50/60 Hz) magnetic field IEC 61000-4-8	3 A/m	3 A/m	Power frequency magnetic fields should be at levels characteristic of a typical location in a typical commercial or hospital environment.

Note: U_T is the A.C. mains voltage prior to application of the test level. Guidance and Manufacturer's Declaration Electromagnetic Immunity

The StimRouter system is intended for home use in addition to use in the electromagnetic environment specified below. The customer or the user of the StimRouter system should assure that it is used in such an environment.

Immunity Test	IEC 60601 Test Level	Compliance Level	Electromagnetic Environment - Guidance
<p>Conducted RF IEC 61000-4-6</p> <p>Radiated RF IEC 61000-4-3</p>	<p>3 Vrms 150 kHz to 80 MHz</p> <p>3 V/m 80 MHz to 2.5 GHz</p>	<p>3 Vrms 150 kHz to 80 MHz</p> <p>10 V/m 26 MHz to 1 GHz</p> <p>3 V/m 1 GHz to 2.5 GHz</p>	<p>Portable and mobile RF communications equipment should be used no closer to any part of the StimRouter system, including cables, than the recommended separation distance calculated from the equation applicable to the frequency of the transmitter.</p> <p>Recommended separation distance (d) $d = 1.2\sqrt{P}$</p> <p>$d = 0.4\sqrt{P}$ 80 MHz to 800 MHz</p> <p>$d = 2.3\sqrt{P}$ 800 MHz to 2.5 GHz</p> <p>Where P is the maximum output power rating of the transmitter in watts (W) according to the transmitter manufacturer and d is the recommended separation distance in meters (m). Field strengths from fixed RF transmitters, as determined by an electromagnetic site survey,^a should be less than the compliance level in each frequency range.^b Interference may occur in the vicinity of equipment marked with the following symbol: </p>

NOTE 1: At 80 MHz and 800 MHz, the higher frequency range applies.

NOTE 2: These guidelines may not apply in all situations. Electromagnetic propagation is affected by absorption and reflection from structures, objects and

people.

Guidance and Manufacturer’s Declaration Electromagnetic Immunity

^a Field strengths from fixed transmitters, such as base stations for radio (cellular/ cordless) telephones and land mobile radios, amateur radio, AM and FM radio broadcast and TV broadcast cannot be predicted theoretically with accuracy. To assess the electromagnetic environment due to fixed RF transmitters, an electromagnetic site survey should be considered. If the measured field strength in the location in which the StimRouter system is used exceeds the applicable RF compliance level above, the StimRouter system should be observed to verify normal operation. If abnormal performance is observed, additional measures may be necessary, such as reorienting or relocating the StimRouter system.

^b Over the frequency range 150 kHz to 80 MHz, field strengths should be less than 3 V/m.

Recommended Separation Distances Between Portable and Mobile RF Communications Equipment and the StimRouter System

The StimRouter system is intended for use in an electromagnetic environment in which radiated RF disturbances are controlled. The customer or the user of the StimRouter system can help prevent electromagnetic interference by maintaining a minimum distance between portable and mobile RF communications equipment (transmitters) and the StimRouter system as recommended below, according to the maximum output power of the communications equipment.

Rated Maximum Output Power of Transmitter W	Separation Distance According to Frequency of Transmitter		
	150 kHz to 80 MHz $d = 1.2\sqrt{P}$	80 MHz to 800 MHz $d = 0.4\sqrt{P}$	800 MHz to 2.5 GHz $d = 2.3\sqrt{P}$
0.01	4.7 in. (0.12 m)	1.6 in. (0.04 m)	9.1 in. (0.23 m)
0.1	15 in. (0.38 m)	4.7 in. (0.12 m)	2 ft. 5 in. (0.73 m)
1	3 ft. 11 in. (1.2 m)	15.7 in. (0.4 m)	7 ft. 7 in. (2.3 m)
10	12 ft. 6 in. (3.8 m)	4 ft. 2 in. (1.26 m)	24 ft. 11 in. (7.3 m)

Rated Maximum Output Power of Transmitter W	Separation Distance According to Frequency of Transmitter		
	150 kHz to 80 MHz $d = 1.2\sqrt{P}$	80 MHz to 800 MHz $d = 0.4\sqrt{P}$	800 MHz to 2.5 GHz $d = 2.3\sqrt{P}$
100	39 ft. 4 in. (12 m)	13 ft. 1 in. (4 m)	75 ft. 6 in. (23 m)

For transmitters rated at a maximum output power not listed above, the recommended separation distance d in meters (m) can be estimated using the equation applicable to the frequency of the transmitter, where P is the maximum output power rating of the transmitter in watts (W) according to the transmitter manufacturer.

NOTE 1: At 80 MHz and 800 MHz, the separation distance for the higher frequency range applies.

NOTE 2: These guidelines may not apply in all situations. Electromagnetic propagation is affected by absorption and reflection from structures, objects and people.